



sigmaline nanoPAC nP4.0

User Manual



COMPANY WITH QUALITY MANAGEMENT
SYSTEM CERTIFIED BY DNV
= ISO 9001:2008 =

User Manual
M.U. nanoPAC NP4.0-2/18.03
Cod. J30 - 478 - 1ANP4 E

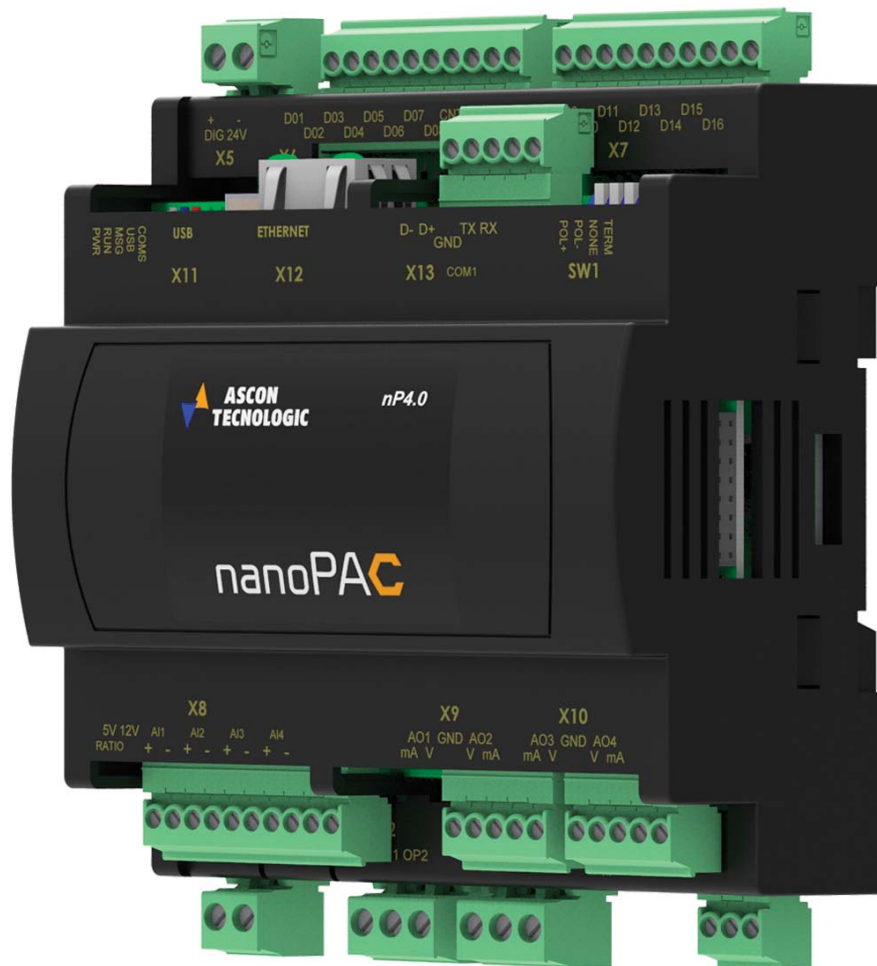

Copyright © 2018 Ascon Tecnologic Srl

All rights reserved

No part of this document may be stored in a retrieval system, or transmitted in any form, electronic or mechanical, without prior written permission of Ascon Tecnologic Srl.

Ascon Tecnologic has used the best care and effort in preparing this manual and believes that the information contained in this publication are accurate.

As Ascon Tecnologic continues to improve and develop products, the information contained in this manual may also be subject to change.

Ascon Tecnologic reserves the right to change such information without notice.

Ascon Tecnologic makes no warranty of any kind, expressed or implied, with regard to the documentation contained in this manual.

Ascon Tecnologic shall not be liable in any event - technical and publishing error or omissions - for any incidental and consequential damages, in connection with, or arising out of the use of this manual.

sigmadue[®], **gammadue**[®] and **deltadue**[®], are trademarks of Ascon Tecnologic Srl.

All other trade names or product names are trademarks or registered trademarks.

Ascon Tecnologic srl

Headquarters: viale Indipendenza 56,
27029 Vigevano (PV)

Phone: +39 0381 69871

Fax: +39 0381 698730

Internet Site: www.ascontecnologic.com

E-mail address: info@ascontecnologic.com

INDEX

Chapter 1

Technical data	1
1-1 General and environmental characteristics	1
1-2 Functional characteristics	1
1-3 I/O Characteristics	2
1-3-1 Digital Channels (D01... D16)	2
1-3-2 Pulse Counter/Frequency Meter Digital Input (CNT1... CNT2)	2
1-3-3 Specific Digital Outputs (OP1... OP4)	2
1-3-4 Universal Analogue Inputs (AI1... AI4)	3
1-3-5 Analogue Output (AO1... AO4)	3
1-3-6 Auxiliary Analogue Output	3
1-4 Communication ports	3
1-4-1 Serial Communication ports (COM1 and COM2)	3

Chapter 2

Hardware description	5
2-1 Architecture	6
2-1-1 Communication ports	6
2-1-2 Integrated I/Os	7
2-1-3 Diagnostic LEDs	8

Chapter 3

Installation	11
3-1 Mechanical installation	11
3-1-1 Installing and Removing the I/O expansion modules	11
3-2 Electrical installation	11
3-2-1 X1: Mains Supply 24 Vdc Power Supply Connector	11
3-2-2 X2, X3: OP1... OP4 Digital Outputs	11
3-2-3 X4: COM2 - RS485 Serial Communication Port Connector	12
3-2-4 X5: Digital channels Power Supply (24 Vdc)	12
3-2-5 X6: D01... D08 Standard Digital I/O & CNT1... CNT2 Pulse counter	12
3-2-6 X7: D09... D16: Standard Digital I/O	12
3-2-7 X8: AI1... AI4: Universal Analogue Inputs & Auxiliary Power	13
3-2-8 X9: AO1... AO2: Analogue Outputs	13
3-2-9 X10: AO3... AO4: Analogue Outputs	13
3-2-10 X11: USB Flash Drive Connector	13
3-2-11 X12: LAN Ethernet 10/100 baseT Connector	13
3-2-12 X13: COM1 - RS 232/485 Communication Port Connector	13

Chapter 4

Communication Ports Configuration	15
4-1 Ethernet communications port	16
4-1-1 Telnet Communications Connection	16
4-2 Optional COM1 serial communications port	17
4-2-1 Configuring the optional COM1 Serial communications port	17
4-2-2 Connect the RS485 serial setup terminal	18
4-2-3 Connect the RS232 serial setup terminal	19
4-3 Configuring the COM2 ModBus Port	20
4-4 Wiring the Modbus Ports	21

Chapter 5

CPU Configuration Session	23
5-1 How to perform the CPU Setup by a Telnet client session	23
5-1-1 Starting the Configuration Session	24
5-2 CPU Main Menu	25
5-2-1 Network Setup Menu	25
5-2-2 Ethernet Setup Menu	26
5-2-3 Serial Setup Menu	26
5-2-4 CPU Setup Menu	27
5-2-5 Startup Setup Menu	27
5-2-6 Persistency Setup Menu	28
5-2-7 RTC Clock Setup Menu	29
5-2-8 Retain Config	29
5-2-9 Modbus TCP/IP Setup	31
5-2-10 Modbus TC/IP Secure Addresses Table Menu	31
5-2-11 Modbus TC/IP Priority Addresses Table Menu	32
5-2-12 Local I/O Setup Menu	32
5-2-13 Setting the AI Channels	33
5-2-14 Analogue Output Ch1 - Ch2 or Ch3 - Ch4 Menu	35
5-2-15 Internal Temperature Menu	37
5-2-16 CPU Info Menu	38

Chapter 6

USB Mass Storage Device	39
6-1 Configuring the CPU with the USB Mass Storage Device	39
6-1-1 Boot-up sequence	39
6-1-2 Upload of the files involved within the PLC program operations ..	40
6-1-3 Download of the files involved within the PLC program operations	40
6-1-4 File system support for the CPU application	40

Chapter 7

CPU Diagnostic Tests	43
7-1 Accessing the diagnostic session	43
7-2 I/O Watch Window	44

Chapter 8

Programming the CPU	45
8-1 Installing OpenPCS	45
8-1-1 Hardware and Software Requirements	45
8-1-2 Installation	45
8-1-3 Starting OpenPCS	45
8-1-4 Configuring OpenPCS	46
8-2 OpenPCS Setup	46
8-3 Watchdog Timer	47

Chapter 9

CPU Configuration Software (TFTP File Access)	49
9-1 TFTP Protocol Access	49
9-2 IEC61131-3 OpenPCS Runtime Errors log file	50

Chapter 10

CPU Data Memory Map	55
10-1 Central Unit Data	56
10-1-1 Standard & Special Digital Inputs Status (D01... D16, CNT1 & CNT2)	56
10-1-2 Universal Analogue Inputs (AI1... AI4)	56
10-1-3 I/O Diagnostic Status	58
10-1-4 Internal Temperature Values	58
10-1-5 Digital Software Counters	59
10-1-6 Standard & Optional Digital Outputs Status (D01... D16, OP1... OP4)	59
10-1-7 Analogue Output Value (AO1... AO4)	59
10-2 Battery, Retain Variables, CPU & EXP Production code Status ..	60
10-2-1 Battery and Retentive Memory Status	60
10-2-2 I/O Configuration Information	60
10-2-3 CPU & Expansions Production Code Management Variables ...	61
10-3 Complete Memory Map	62
10-3-1 Input Memory Areas	62
10-3-2 Output Memory Areas	64
10-3-3 Marker Memory Areas	64

Chapter 11

Ascon Tecnologic Function Blocks Libraries	67
11-1 AT_Generic_Advanced_Lib	67
11-2 AT_Process_Generic_Lib	68
11-3 AT_Process_Control_Lib	69
11-4 AT_Communications_Lib	69
11-5 AT_Firmware_FBs List	71

Appendix A

The Bootloader in the PAC project	73
A-1 How to update the CPU Firmware	73
A-2 Bootloader Startup	73
A-3 Remote Firmware Update	74
A-4 Local Firmware Update	74
A-5 Update Firmware reference Tables	75

Appendix B

AT SigmaPAC Wizard Tool	77
B-1 User Interface	77
B-2 How to perform the CPU Setup	81
B-2-1 Create a new Configuration project	81
B-3 Network Setup	83
B-3-1 Ethernet Setup Menu	83
B-3-2 Serial Setup Menu	83
B-3-3 CanOpen Menu	83
B-4 CPU Setup	84
B-4-1 Startup Setup Menu	84
B-4-2 Persistency Setup Menu	84
B-4-3 Retain Config	85
B-5 Modbus TCP/IP Setup	86
B-5-1 Modbus TC/IP Secure Addresses Table Menu	86
B-5-2 Modbus TC/IP Priority Addresses Table Menu	86
B-6 Local Analogue I/O Setup Menu	87
B-6-1 Setting the AI Channels	87
B-6-2 Analogue Output Ch1 - Ch2 or Ch3 - Ch4 Menu	88
B-7 Local Digital I/O Setup Menu	88
B-7-1 Configuring the Digital I/Os type	88
B-7-2 Digital Input/Output Config	89

Appendix C

Reference documents	93
----------------------------------	-----------

Prerequisites

The products described in this manual should be installed, operated and maintained only by qualified application programmers and software engineers who are familiar with EN 61131-3 concepts of PLC programming, automation safety topics, and applicable national standards.

Using this manual

Specifications within the text of this manual are given in the International System of Units (SI), with non SI equivalents in parentheses.

Fully Capitalized words within the text indicate markings found on the equipment.

The references to other manuals are pointed out with a number between brackets. The number indicates the position of the manual in the list in: “Appendix C - Reference documents” on page 93.

Words **in bold** style within the text indicate markings found in the Configuration Tools.

Dangers, Warnings, Cautions and Notes are used to emphasize critical instructions:



DANGER!

Indicates an imminently hazardous situation which, if not avoided, will result in death or serious injury.



WARNING

Indicates a potentially hazardous situation which, if not avoided, could result in death or serious injury.



Caution

Indicates a potentially hazardous situation which, if not avoided, may result in minor or moderate injury, or property damage.

Note: Highlights important information about an operating procedure or the equipment.

Current Documentation on the Internet

Make sure you are always working with the latest version of this document.

Ascon Tecnologic Srl reserves the right to make changes to its products in the name of technological advancement. New documents revisions, when published can be found online at:

<http://www.ascontecnologic.com>

Chapter 1

Technical data

1-1 General and environmental characteristics

Features	Description
Power supply	24 Vdc (-15... +25 %)
Power consumption	12 VA (+5 W with I/O modules)
Operating temperature	-20... 50°C (-4... 122°F)
Storage temperature	-40... 70°C (-40... 158°F)
Relative Humidity	5...95 % w/o condensation
Mounting	Omega DIN A rail
Dimensions	W: 108 H: 110 D: 60 (mm) - 6 DIN module
Weight	512 g
Protection Degree	IP20
Safety	Compliance to EN 61131-2 Isolation class II (50 Vrms), EN61010-1
Approvals	CE (UL pending)

1-2 Functional characteristics

Features	Description
Programming languages	IL, ST, FBD, LD, SFC, CFC
Program memory	Max. 4 MB internal or on USB key
Dynamic memory	32 MB SDRAM
Retentive memory	64 kB redundant – 128 kB MRAM
Data retention (for power failure)	15 years (for Flash memory)
Min. cycle time	Typical 7 ms
Max. timer resolution	1 ms
Real Time Clock	With rechargeable backup battery
Max. PID number	Unlimited, application or cycle time dependent

1-3 I/O Characteristics

1-3-1 Digital Channels (D01... D16)

Features	Description
Type	Configurable as Digital Input (OFF = 0... 3 V, ON = 5... 30 V) or Digital Output (24 Vdc, 0.7 A each)
Isolation	800 V channels/power supply
	800 V channels/logic components
Compliance	IEC/EN 61131-2 (type 1)
Terminal connectors	X6 and X7

Note: The watchdog timer function output, in case, is the DO16.

1-3-2 Pulse Counter/Frequency Meter Digital Input (CNT1... CNT2)

Features	Description
Type	Configurable as Standard DI, Pulse Counter or Frequency-meter (up to 5 kHz)(note)
Isolation	800 V channels/power supply
	800 V channels/logic components
Compliance	IEC/EN 61131-2 (type 1)
Terminal connectors	X6

Note: The Frequency meter function will be available in a future release.

1-3-3 Specific Digital Outputs (OP1... OP4)

OP1 to OP4 are designed to be Digital Outputs only: the type can be selected from the ordering code as Relay (code **R**), SSR drive (code **S**) or Mixed (code **M**).

2 A SPST Relay OP1... OP4 as relay outputs with SPST (Single pole, single throw).

Features	Description
Contact configuration	SPST (Single Pole, Single Throw)
Contact rate	2 A (for resistive loads)
Isolation	3 kV between channel and Power Supply and between channel and main electronics
Output connectors	X2 and X3

0/12 Vdc external SSR OP1... OP4 as 0/12 Vdc outputs for SSR drive.

Features	Description
Power output	10 mA, 12 Vdc
Isolation	None
Output connectors	X2 and X3

1-3-4 Universal Analogue Inputs (AI1... AI4)

AI1... AI4 are Universal Analogue Inputs that can be configured from the Setup Telnet session.

Features	Description
Type of input	0/4... 20 mA, 0/1... 5 V, 0/2... 10 V, Thermocouple (type J, K, L, N, R, S, T), PT100 (2 wires), PT1000, NTC (Semitec 103AT-2), Potentiometer or 5 V Ratiometric
Resolution	16 bit
Accuracy	0.1 % of span (linear inputs)/0.2% (Temperature)
Input impedance	120 k Ω (V), < 200 Ω (mA)
Isolation	800 V between analogue outputs, power supply, digital I/Os and communication ports (when isolated)
Input connectors	X8

1-3-5 Analogue Output (AO1... AO4)

AO1... AO4 are the Analogue Outputs which can be configured from the Setup Telnet session.

Features	Description
AO1... AO4 [note]	0/1... 5 V, 0/2... 10 V, 0/4... 20 mA
Load	< 500 Ω (mA), > 1 k Ω (V)
Resolution	12 bit
Accuracy	0.1% full scale
Isolation	800 V between analogue outputs, power supply, digital I/Os and communication ports (when isolated)
Connector	X9 and X10

Note: All the available input types are listed at: “Setup Temperature Channels” on page 31 and “Setup the Selected AI Channel” on page 30.
All the available output types are listed at: “AO Channels Setup Menu” on page 33.

1-3-6 Auxiliary Analogue Output

Features	Description	
Power output 1	+5 Vdc	Ratiometric sensor power supply
	30 mA max.	Max. load
	X8	Output terminal connector
Power output 2	+12 Vdc	Passive transmitter power supply
	80 mA max.	Max. load
	X8	Output terminal connector

1-4 Communication ports**1-4-1 Serial Communication ports (COM1 and COM2)**

Features	Description
Isolation	800 V between analogue inputs, analogue outputs, digital IOs, power supply and each other (optional)
Connector	X13 (COM1) and X4 (COM2)

Chapter 2

Hardware description

The system described in this User Manual is mainly composed by:

- Ascon Technologic **nanoPAC nP4** CPU which can be equipped up to 4 universal analogue inputs (mA, V, thermocouple, PT100, PT1000, NTC, potentiometer or 5 V Ratiometric), 4 high level analogue outputs (mA or V), 16 digital IOs, up to 4 SPST relays or SSR drive and 2 fast DI for pulse counts (available soon) or frequency (up to 5 kHz).
- **exPAC** local or remote I/O (ModBus or CANopen) expansion modules;
- Infoteam **OpenPCS** programming tool system.

nanoPAC nP4 is part of the **sigmaline** family and is based on a powerful CPU board powered by an ARM Cortex 32 bit processor with Real Time clock, operating in conjunction with various type of memory which guarantee a very efficient management of all on-board specific I/Os and allows to handle, simultaneously, up to 3 communication ports.

sigmaline exPAC is a family of flexible analogue and/or digital I/O expansion modules, with special functions, which can be also connected to the **nP4** CPU module through a dedicated communication port (with ModBus or CANopen fieldbus).

Infoteam **OpenPCS** is a powerful and useful EN61131-3 compliant programming tool for PLC applications.

It is a clearly structured and easily operated tool to edit, compile, debug, manage and print PLC applications during all the development phases.

OpenPCS can operate on Windows 7[®], Windows 8[®] and Windows 10[®] (32 or 64 bit) platforms.

The Ascon Technologic **nP4** unit based on **sigmaline** technology, combines its control capabilities with the functionalities of a PLC. “*Modular concept*” means that you can adapt the system quickly and easily to your requirements: this gives to the **sigmaline** automation systems an amazing price/performance ratio.

This User Manual handbook introduces you to the **sigmaline nP4** solution and the Infoteam **OpenPCS** programming tool.

It explains how to install the hardware and software and how to start up the system. Information on maintenance, troubleshooting and services are also included.

2-1 Architecture

From the programmer's point of view, a complete system can be arranged as in "Figure 2.1 - Programming the sigmaline nP4 Control Unit" below:

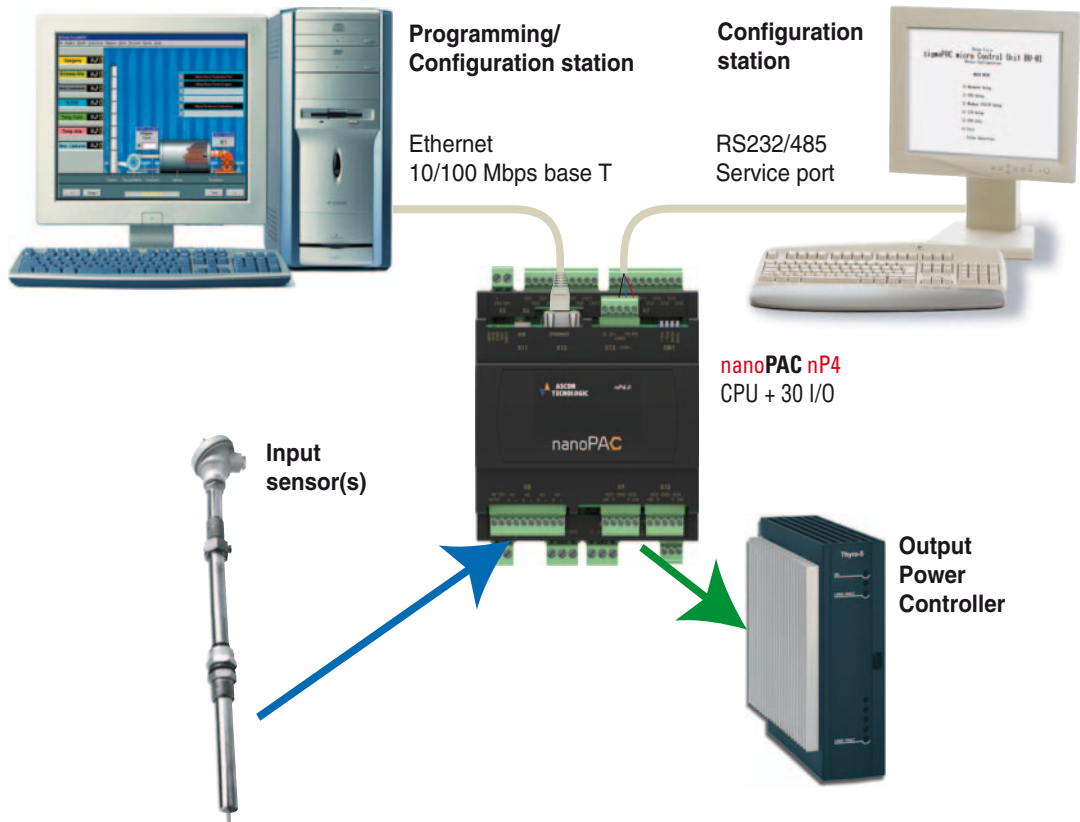

Figure 2.1 - Programming the **sigmaline nP4** Control Unit

In "Figure 2.1 - Programming the sigmaline nP4 Control Unit" the configuration station (VT100 terminal) and the PC with OpenPCS are displayed as two different devices, but it is possible to use just one PC to run both (e.g. PuTTY/HyperTerminal).

2-1-1 Communication ports

The CPU has 3 communication ports (see "Chapter 2 - Control Unit Supply, I/O and Communication Ports"):

- An Ethernet port (TCP/IP) which can be used to perform:
 - CPU configuration using a Telnet client session;
 - Programming, debugging and commissioning;
 - Modbus TCP data exchange;
- An RS485/232 port (connector X13) to perform:
 - Standard ASCII protocol communication;
 - Modbus RTU master/slave communication data exchange.
- A second RS485 port (connector X4) to perform:
 - Standard ASCII protocol communication;
 - Modbus RTU master/slave communication data exchange.
- An USB port which can be used to perform data logging, backup/restore function of project files (uploading or downloading configuration and/or programs to/from an external USB mass memory storage), firmware backup/upgrade.

Pinout of all communication ports is described hereafter and in: "**nP4 Installation Manual**" [9].

2-1-2 Integrated I/Os

The **sigmaline nP4** base unit can house up to 30 I/O ports:

- 4 AI Universal analogue inputs configurable as mA, V, thermocouple, PT100, Pt1000, NTC, potentiometer or 5 V ratiometric (connector X8);
- 0/2/4/ AO High level analogue outputs mA or V (connector X9 and X10);
- 16 DIG Configurable Digital Inputs or Outputs 24 Vdc (connectors X6 and X7);
- 2 DI Standard digital input, pulse counter or frequency meter (up to 5 kHz)(connector X6);
- 4 OP General purpose digital outputs: SPST relay (2 A) or SSR drive (connectors X2 and X3).

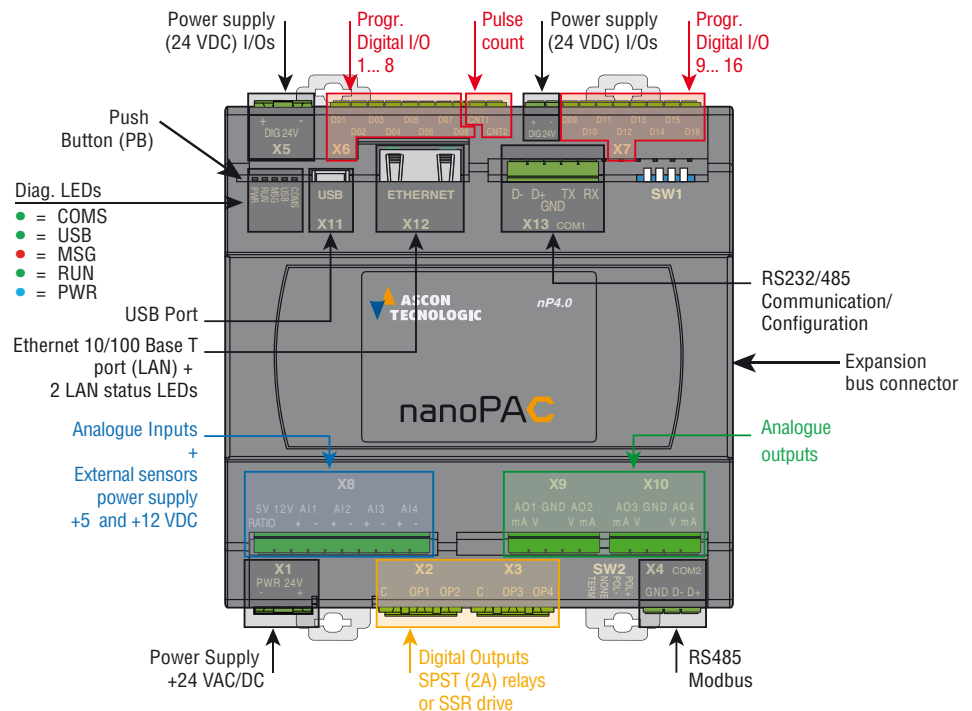

Figure 2.2 - Control Unit Supply, I/O and Communication Ports



WARNING

The **PB** button performs different operations accordingly to the system status but **does not restart** the CPU or the 1131 application.



WARNING

- 1) By pressing the **PB** button at the CPU power ON it is possible to **restore the Factory Default parameters**.
- 2) Immediately after CPU Power ON, if a recognized USB key is present, by pressing the **PB** button will be possible to manage the upload / download of all the files related to the project from / to the USB Key as described in the “Chapter 6 - USB Mass Storage Device”.
- 3) While the PLC program is running, if the **PB** button will be pressed, it behaves as a Standard digital input as described in “Chapter 10 - Digital Inputs Status (D01... D16)”.

2-1-3 Diagnostic LEDs

Accordingly to “Chapter 2 - Control Unit Supply, I/O and Communication Ports” the hereafter tables describe in detail LED functions and behaviours (*Note 1).

LED	Colour	Action (note 1)	Description
PWR	Blue	ON	Power Supply present
RUN LED while normal CPU or Bootloader operations			
RUN	Green	OFF	PLC Program stopped or not present
		ON	PLC Program running
		Blinking	Telnet Watch Monitor session active
		Flickering	Telnet Configuration session active
		Single flash	Bootloader - Work in progress
		Double flash	Bootloader - Operations result OK
		Triple flash	Bootloader - Operations result KO
MSG LED while normal CPU or Bootloader operations			
MSG	Red	OFF	No Errors - Firmware present
		ON	Firmware not present
		Blinking	Backup battery low
		Flickering	Flash File System error
		Single flash	Checksum error in RETAIN data
		Double flash	Calibration file error
		Triple flash	Configuration error (Reset to Factory Default)
USB LED while normal CPU or Bootloader operations			
USB	White	OFF	Reserved
		ON	USB Host key present
		Blinking	Access to USB key
		Flickering	File transfer active
		Single flash	Wait for PB button to USB files management
		Double flash	Reserved
		Triple flash	Reserved
COMS LED while normal CPU or Bootloader operations			
COMS	Green	OFF	Reserved
		ON	Bootloader - USB host
		Blinking	Bootloader - TFTP with IP as Factory default
		Flickering	Bootloader - TFTP with customer's IP
		Single flash	COM1 data traffic
		Double flash	COM2 data traffic
		Triple flash	COM1 and COM2 data traffic

Table 2.1 - Diagnostic LEDs description

- Notes:** 1. As the ON/OFF sequence of the LEDs has a specific meaning, it is important that the user recognizes each LED status:

Sequence	Meaning
OFF	The LED is not lit
Steady ON	The LED is lit in a stable way
Blinking	The LED blinks at a frequency of 2.5 Hz (slow)
Flickering	The LED blinks at a frequency of 10 Hz (fast)
Single flash	The LED lites once for at least 200 ms
Double flash	The LED lites twice with pulses of 200 ms each
Triple flash	The LED lites three with pulses of 200 ms each

2. The first time %M variables have been defined as RETAIN (see “*Chapter 5 - Retain Config Menu*”), the system needs to reboot in order to properly create the dedicated files. The error indication will disappear automatically in case of positive result.



WARNING

While the CPU is writing a new firmware to the internal Flash memory, an alternate blinking between the RUN and MSG + USB + COMS LEDs will indicate the status and progress of the reserved specific operations!

In case of problem to access internal File System, the CPU could perform a format of it: in this particular specific case, ALL the LEDs will blink in a way which simulates a bargraph filling!

Chapter 3

Installation

3-1 Mechanical installation

The **sigmaline nanoPAC nP4 CPU** and the additional external expansion I/O units are designed to be installed on standard DIN rails

The expansion connector port of nP4 CPU is located on the right side of the case. For this reason, please reserve enough space in case of needs of expansion modules. Max. two additional external I/O expansion units managed by an **nP4 CPU**.

3-1-1 Installing and Removing the I/O expansion modules

A complete description about how a CPU or expansion modules can be connected or removed can be found in the “nP4 Installation Manual” [9].

3-2 Electrical installation

Refer to: “Figure 2.2 - Control Unit Supply, I/O and Communication Ports” and “nP4 Installation Manual” [9] for details.

3-2-1 X1: Mains Supply 24 Vdc Power Supply Connector

This 2 terminals connector brings the Power Supply to the CPU.

3-2-2 X2, X3: OP1... OP4 Digital Outputs

These two 3 terminals connectors are used for the output channels from OP1 up to OP4. Depending on the ordering code (fields **B**) the outputs can be:

Order Code M X2 - 2 A SPST output relays - Terminals Pinout:

Label	C	OP1	OP2
Signal	Common	Normally Open	Normally Open

X3 - 0/12 Vdc outputs for SSR - Terminals Pinout:

Label	C	OP3	OP4
Signal	⁺ (Positive pole)	⁻ (Negative pole)	⁻ (Negative pole)

Order Code R X2 - 2 A SPST output relays - Terminals Pinout:

Label	C	OP1	OP2
Signal	Common	Normally Open	Normally Open

X3 - 2 A SPST output relays - Terminals Pinout:

Label	C	OP3	OP4
Signal	Common	Normally Open	Normally Open

Order Code **S** X2 - 0/12 Vdc outputs for SSR - Terminals Pinout:

Label	C	OP1	OP2
Signal	⁺ (Positive pole)	⁻ (Negative pole)	⁻ (Negative pole)

X3 - 0/12 Vdc outputs for SSR - Terminals Pinout:

Label	C	OP3	OP4
Signal	⁺ (Positive pole)	⁻ (Negative pole)	⁻ (Negative pole)

3-2-3 X4: COM2 - RS485 Serial Communication Port Connector

Through this connector is possible to activate the RS485 serial communication port only.

A dedicated DIP switches bank allows to activate the electrical line polarization (+ and/or -) and/or termination (see the “Installation Manual for more information”).

The X4 RS485 connector provides the port to connect a fieldbus network using the Modbus protocol (master/ slave) or serial ASCII.

The connector has the following pinout:

Label	GND	D+	D-
Signal	Ground	Data +	Data -

3-2-4 X5: Digital channels Power Supply (24 Vdc)

This connector has been designed to expressively power the digital channels section of the CPU. The connector has the following pinout:

Label	+	-
Signal	24 Vdc	0 Vdc

3-2-5 X6: D01... D08 Standard Digital I/O & CNT1... CNT2 Pulse counter

Through this connector is possible to manage the standard configurable digital channels from D01 up to D08 and the special fast pulse counter/frequency digital inputs. The connector has the following pinout:

Label	D01	D02	D03	D04	D05	D06	D07	D08	CNT1	CNT2
Signal	DI/DO 01	DI/DO 02	DI/DO 03	DI/DO 04	DI/DO 05	DI/DO 06	DI/DO 07	DI/DO 08	Pulse Count1	Pulse Count2

3-2-6 X7: D09... D16: Standard Digital I/O

Through this connector is possible to manage the standard configurable digital channels from D09 up to D16. The connector has the following pinout:

Label	+	-	D01	D02	D03	D04	D05	D06	D07	D08
Signal	24 Vdc	0 Vdc	DI/DO 09	DI/DO 10	DI/DO 11	DI/DO 12	DI/DO 13	DI/DO 14	DI/DO 15	DI/DO 16

3-2-7 X8: AI1... AI4: Universal Analogue Inputs & Auxiliary Power

This connector is dedicated to the AI management and provide also 2 different power supply for ratiometric signals (+5 Vdc) and passive transmitters (+12 Vdc). The connector has the following pinout:

5V RATIO, 12V & AI1... AI4 - Universal Analogue Inputs

Label	5V RATIO	12V	AI1 +	AI1 -	AI2 +	AI2 -	AI3 +	AI3 -	AI4 +	AI4 -
Signal	+5 Vdc	+12 Vdc	AI1 signal reference		AI2 signal reference		AI3 signal reference		AI4 signal reference	

3-2-8 X9: AO1... AO2: Analogue Outputs

The X9 connector is used to connect the first two Analogue Outputs (AO1 & AO2) to the system. The connector has the following pinout:

Label	AO1 mA	AO1 V	GND	AO2 V	AO2 mA
Signal	AO1 Current +	AO1 Voltage +	Common (-)	AO2 Voltage +	AO2 Current +

3-2-9 X10: AO3... AO4: Analogue Outputs

The X10 connector is used to connect the last two Analogue Outputs (AO3 & AO4) to the system. The connector has the following pinout:

Label	AO3 mA	AO3 V	GND	AO4 V	AO4 mA
Signal	AO3 Current +	AO3 Voltage +	Common (-)	AO4 Voltage +	AO4 Current +

3-2-10 X11: USB Flash Drive Connector

The X11 connector is a standard **USB Type AB** port to connect a flash drive (system files, firmware and/or data logging upload/download).

3-2-11 X12: LAN Ethernet 10/100 baseT Connector

The X12 connector is a standard Ethernet RJ45 type.

3-2-12 X13: COM1 - RS 232/485 Communication Port Connector

Through this connector is possible to activate the RS485/232 serial communication port only.

A dedicated DIP switches bank allows to activate the electrical line polarization (+ and/or -) and/or termination (see the "*Installation Manual*" for more information).

To select the desired operational mode (RS485 or RS232) please consult the "*5-1 - How to perform the CPU Setup by a Telnet client session*" on page 23 for details.

The **X13** RS485/232 connector provides the port to connect a fieldbus network using the Modbus protocol (master/ slave) or serial ASCII.

The connector has the following pinout:

Label	D-	D+	GND	TX	RX
Signal	Data -	Data +	RS485/232 Ground	RS232 Transmit	RS232 Receive

Chapter 4

Communication Ports Configuration

The **nP4** system unit can have up to 3 different communication ports (see “*Figure 2.2 - Control Unit Supply, I/O and Communication Ports*” for details):

- X12** Ethernet port (TCP/IP) can be used to configure, program, debug, commission and for Modbus TCP data exchange;
 - X13** COM1 can be set, through the Telnet configuration session, as RS232 or RS485 and can be used also as “*Service port*” to configure the Basic Unit as well as a Modbus/ASCII communications;
 - X4** COM2 can be an RS485 dedicated to Modbus/ASCII communications only.
-



Caution

The optional COM1 serial communications port is, by default, set as **RS485**, this fact means that the COM1 port cannot be used as RS232 service port the first time that the CPU is Powered ON. To use The COM1 port as RS232, the CPU must be set up with a telnet session on the Ethernet port as a configuration file with the COM1 set as RS232 command inside must be sent to the CPU using the Ethernet port.



WARNING

The maximum data blocks length manageable by the **nP4** over a Modbus slave RTU/TCP session is 44 WORD (22 REAL). Pay particular attention when connecting the CPU to a Modbus network in order to verify that the Modbus Master/Client respects the limits to avoid any possible communication errors or problems (it **MUST** be equal or less than 44 WORD).

4-1 Ethernet communications port

Setup data can be entered by using a Telnet Client session, establishing the connection through the Ethernet that is always present on the CPU.

4-1-1 Telnet Communications Connection

In order to connect the CPU to a Personal Computer using the Ethernet port there are two possibilities:

1. **Through a Switch or a HUB (nP4 -> HUB/Switch -> PC).**

Plug into the Ethernet connector a patch LAN cable (not crossed) to connect the CPU to a switch or HUB (the connection between the HUB is also a straight through connection).

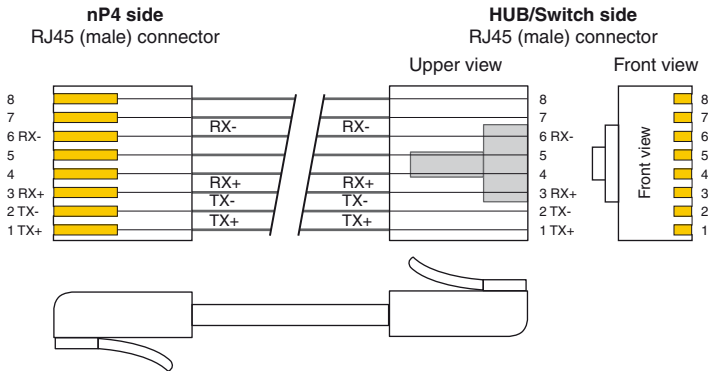

2. **Directly to the Personal Computer**

Plug into the Ethernet connector a crossed LAN cable to connect the CPU directly to the PC.

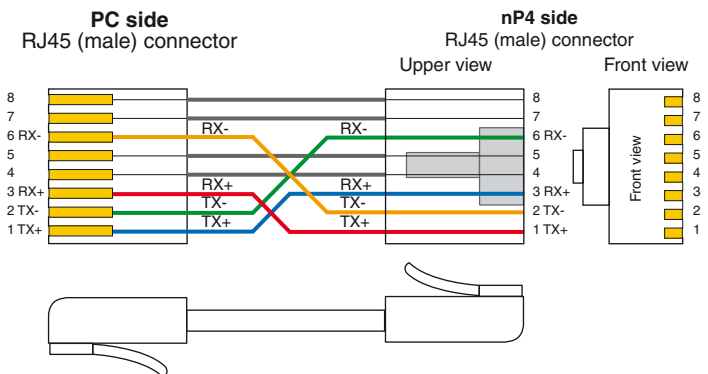

WARNING

Even if many Personal Computers (and Ethernet switches) are able to fully manage a connection by switching the signals to match the type of connection made (patch or crossed), is suggested to use the correct type of cable.

Once the PC is connected to the CPU, start the Telnet program in order to establish the connection with the nP4 and begin the setup session.

Setting the communications parameters

At this point the user must configure the Telnet Client in order to communicate with the CPU as reported in the following table:

IP Address	192.168.5.11 (Factory default)
Port	23

4-2 Optional COM1 serial communications port

4-2-1 Configuring the optional COM1 Serial communications port

The COM1 serial port is optional: the termination resistance and the line polarization can be configured through a dedicated DIP switch bank, located nearby to the Serial Ports connector. The **X13** COM1 Port can be used to configure the CPU using a Telnet session. The RS485/232 COM1 connector is located in the upper-central side of the CPU.

Looking at the connector, the 5 terminals are arranged as illustrated.

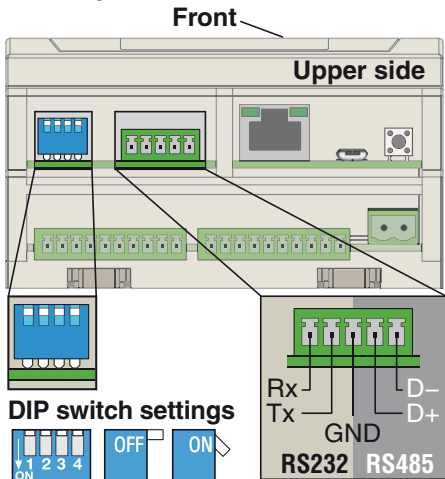

RS232/485 COM1 connector + DIP switches

Figure 4.1 - Position of the COM1 serial port configuration DIP switches

The signals present on the COM1 port terminals are (as printed on **nP4** case).

Signal	Protocol
RX	RS232
TX	RS232
GND	RS485/232
D+	RS485
D -	RS485

Some electrical hardware settings related to the COM1 port can be configured using the specific dedicated DIP switches.

The following table explains the possible choices:

Switch	Function	ON	OFF
1	Line Termination (110Ω)	Active	Disabled (Default)
2	Reserved	N.A.	N.A.
3	Polarization Line •	Active	Disabled (Default)
4	Polarization Line +	Active	Disabled (Default)

The default communication parameters for the **X13** port are for RS485 and RS232:

Baud Rate: 9600 bps, Data: 8 bit, Stop bit: 1, Parity: none.

The serial port communication parameters can be changed during the CPU Setup Session (see paragraph: "Serial Setup Menu" on page 26 for details).



Caution

The RS232 cable must be shorter than 15 m.

4-2-2 Connect the RS485 serial setup terminal

In order to correctly perform the configuration, the user should:

- Prepare a proper communication connection cable;
- Connect the Personal Computer using an USB to RS485 converter;
- Set the correct communications parameters;
- Run the communication Telnet Client program.

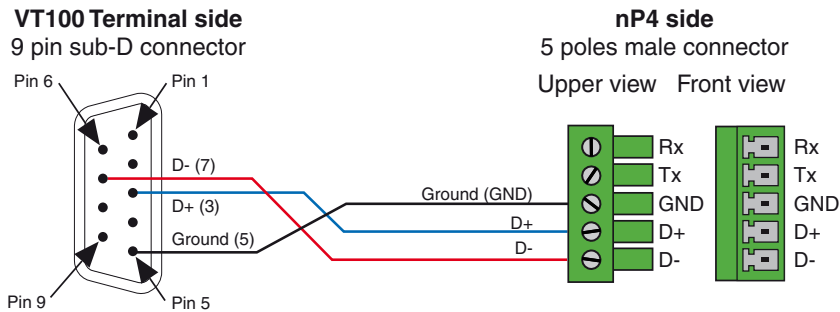

Figure 4.2 - RS485 Serial Communications Connection

Setting the comm.s parameters

The Telnet client program (HyperTerminal) must be configured accordingly to the communication port desired. If the Personal Computer has no serial ports, the connection can be made through an USB to RS485 adapter: find out the COM number assigned by your OS to it following “Start\ControlPanel\System\Hardware\Peripherals\Ports (COM and LPT)”.

Using the COM port number, open a new session of the Telnet client program and set the communication parameters to match the ones of the service port

Baud rate	9600
Data	8 bit
Stop bit	1
Parity	None

From the configuration session, it will be possible to change the baud rate, stop bit and parity (see “Serial Setup Menu” on page 26 for details): if the system communications parameters have been modified, please remember to adjust the PC or VT100 terminal ones in order to match all each other.

4-2-3 Connect the RS232 serial setup terminal

In order to correctly perform the configuration, the user should:

- Set the **X13** port as RS232 via the Ethernet port or a configuration file sent to the CPU;
- Prepare a proper communication connection cable;
- Connect the Personal Computer to an RS232 port or using an USB to RS232 converter;
- Set the correct communications parameters;
- Run the communication Telnet Client program.

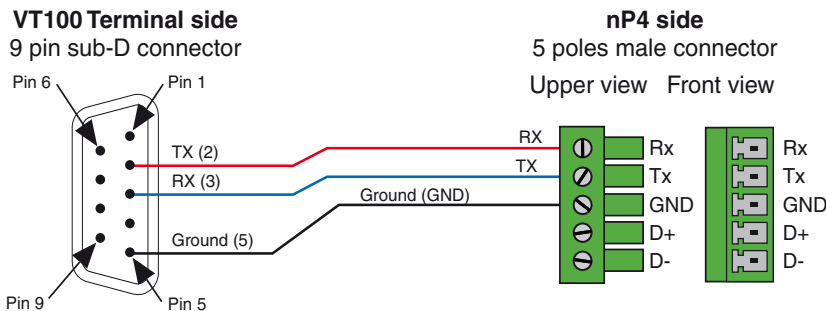

Figure 4.3 - RS232 Serial Communications Connection

Setting the comm.s parameters

The Telnet client program (HyperTerminal) must be configured accordingly to the communication port desired. If the Personal Computer has no serial ports, the connection can be made through an USB to Serial adapter: find out the COM number assigned by your OS to it following “Start\Control Panel\System\Hardware\Peripherals\Ports (COM and LPT)”.

Using the COM port number, open a new session of the Telnet client program and set the communication parameters to match the ones of the service port

Baud rate	9600
Data	8 bit
Stop bit	1
Parity	None
Flow Control	None

From the configuration session, it will be possible to change the baud rate, stop bit and parity (see “Serial Setup Menu” on page 26 for details): if the system communications parameters have been modified, please remember to adjust the PC or VT100 terminal ones in order to match all each other.

4-3 Configuring the COM2 ModBus Port

When present, the COM2 port can be also used for Modbus communication activities. The **X4** RS485 port connector is located in the **lower-right side** of the CPU. Looking at the connector, the 3 terminals are arranged as illustrated in the drawing.

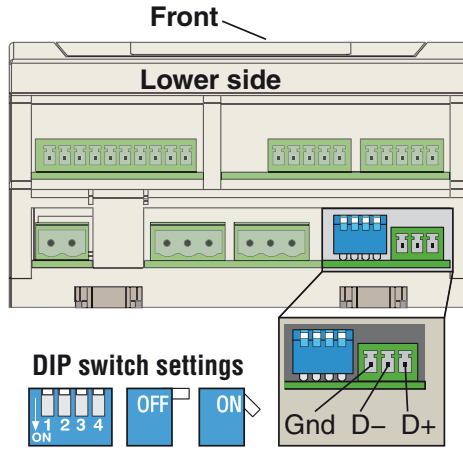

COM2 connector + DIP switches

The signals present on the COM2 port terminals are (as printed on nP4 case):

Signal	Protocol
D+	Data + terminal
D•	Data • terminal
GND	Ground terminal

Some electrical hardware settings related to the COM2 port can be configured using the specific dedicated DIP switches.

The following table explains the possible choices:

Switch	Function	ON	OFF
1	Line Termination (110Ω)	Active	Disabled (Default)
2	Reserved	N.A.	N.A.
3	Polarization Line •	Active	Disabled (Default)
4	Polarization Line +	Active	Disabled (Default)



WARNING

The default communication parameters can be set only by using the specific Function Block. See “*AT_Firmware_Lib [3]*” for details.

4-4 Wiring the Modbus Ports



Caution

To properly connect over one of the RS485 fieldbus ports (through the **X13** and/or **X4** ports), it is strongly recommended to use cables specifically designed for such type of communications such as the Belden model 9501 or 9841 (or equivalent).

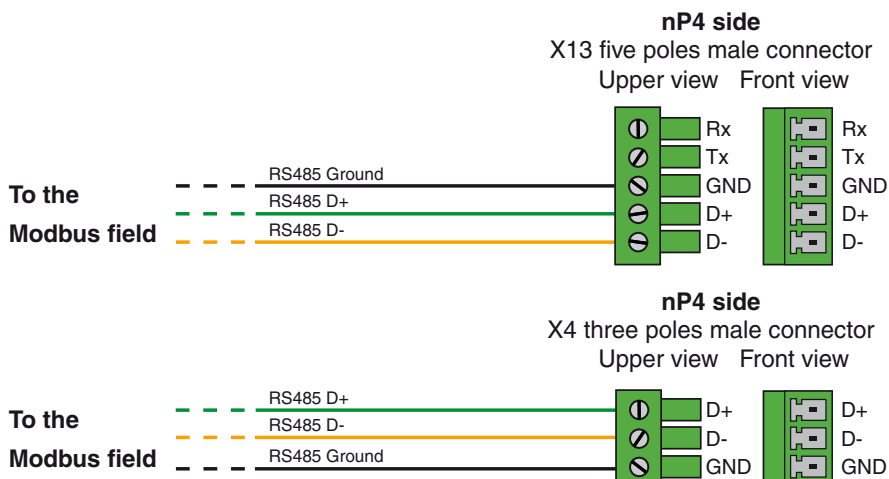

Chapter 5

CPU Configuration Session

While boot-up, the system has a time frame window (10 seconds as default) which can be used by the operator to access the configuration session and setup the CPU system module and configure the system I/Os.

Setup data can be entered by using a Telnet Client session, establishing the connection through the Ethernet, the RS485 or the RS232 port.

5-1 How to perform the CPU Setup by a Telnet client session

There are 2 ports available on the CPU to enter the configuration session: the Ethernet LAN port or the **X13** RS485/232 serial port. Depending on the setup method used, the user must:

- Set the **X13** or the LAN port (consult the “*nP4 Installation Manual*” [9] for details);
- Use the proper connection cable;
- Set the correct communications parameters;
- Run the communications program.



Caution

Chapter 4 describes the connection setup details and COM ports configuration.

Once the Telnet client program (VT100 or PC) has been correctly connected to the **nP4** CPU, the user can start to operate the configuration session.

5-1-1 Starting the Configuration Session

Accessing the Main Menu

To open the Configuration session, while the CPU powers ON and the RUN LED will start blinking, establish the connection by pressing the **ENTER** key from the setup terminal window. If there is no activity by the operator until a predefined time (as default, 10 seconds) the system skips the configuration time window and runs the project application (if present). This chapter describes in detail the specific sections of the configuration session and shows the major screenshot used for such type of operations.

If the connection has been successfully established, the welcome screen appears as follows:

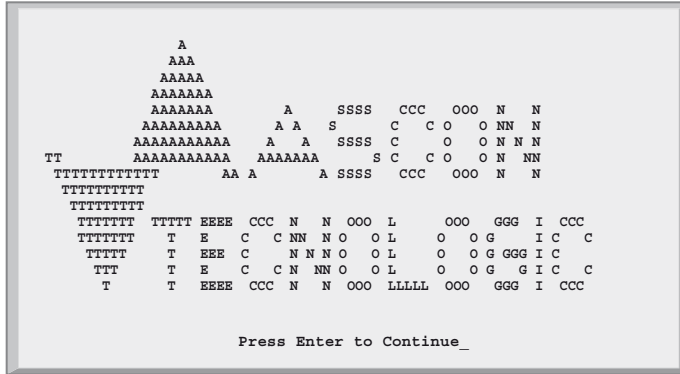

Now press **ENTER** key again to jump into the Main Menu screen. Please note that the system has 120 seconds of inactivity timeout. If the user does not perform any operation up to that amount of time, the configuration session will be automatically aborted and the project application will be started (if present). Both the above described timeouts are part of the setup parameters available from the configuration session: it is not recommended to set these values too small in order to avoid undesired configuration session aborts. To select an item from a menu or to insert a value for a parameter, the user must type the corresponding selection number and press **ENTER**.

5-2 CPU Main Menu

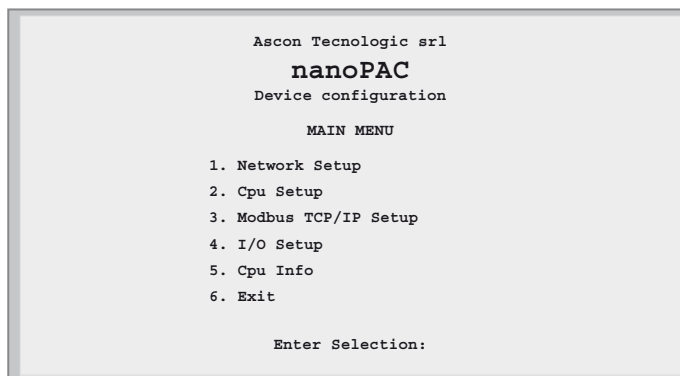

Figure 5.1 - Base Unit configuration Main Menu

The Main Menu (Figure 5.1 -) has 6 different choices:

Item	Description
Network Setup	CPU communication ports settings
CPU Setup	Specific CPU parameters
ModbusTCP/IP Setup	Modbus TCP/ IP Settings
I/O Setup	Onboard I/O Configuration
CPU Info	Firmware and hardware information
Exit	End the configuration session

5-2-1 Network Setup Menu

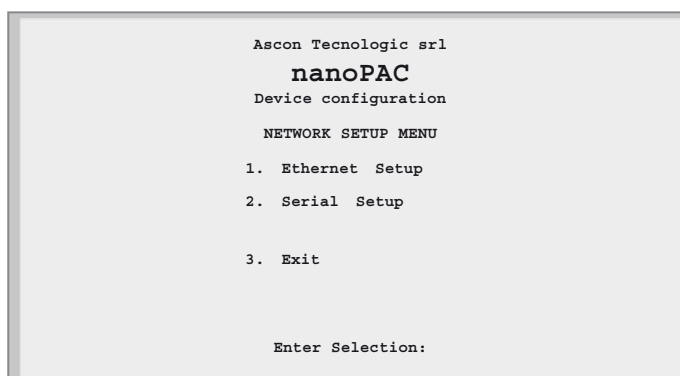

Figure 5.2 - Network Setup Menu

Item	Description
Ethernet Setup	Ethernet Setup Parameters
Serial Setup	Serial COM1 Setup Parameters
Exit	Return to previous menu

5-2-2 Ethernet Setup Menu

This menu can be used to configure the COM1 serial port to fulfil the desired operational mode.

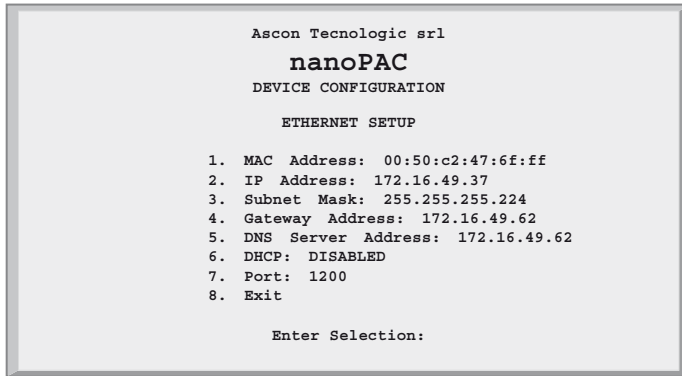

Figure 5.3 - Ethernet Setup Menu

Item	Description	Range	Factory Default
MAC Address	Device MAC Address	-	00:50:c2:47:xx:xx
IP Address	CPU IP Address	0.0.0.0/255.255.255.255	192.168.5.11
Subnet Mask	CPU subnet mask	0.0.0.0/255.255.255.255	255.255.255.0
Gateway Address	Network Gateway Address	0.0.0.0/255.255.255.255	192.168.5.10
DNS Server Address	DNS Server Address	0.0.0.0/255.255.255.255	192.168.5.10
DHCP	DHCP Protocol Status	0/1	Disabled
Port	OpenPCS Port Number	0... 65535	1200
Exit	Return to previous menu	-	-

5-2-3 Serial Setup Menu

This menu must be used to configure the COM1 serial port to different values from the default (9600 baud/s, no parity, 1 stop bit) for the COM1 port.

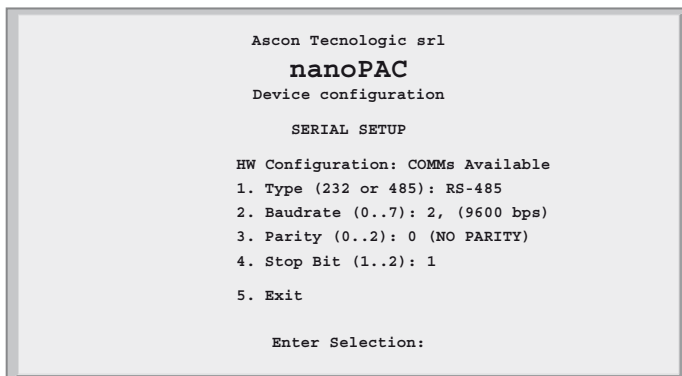

Figure 5.4 - Serial Setup Menu

Item	Description	Range	Factory Default
Type	COM1 type	0/1 [RS485/RS232]	RS485
Baudrate	COM1 baudrate	0... 6 [2400... 57600]	9600
Parity	COM1 parity	0... 2 [None/Even/Odd]	None
Stop bit	COM1 stop bit	1/2	1
Exit	Return to previous menu	-	-

5-2-4 CPU Setup Menu

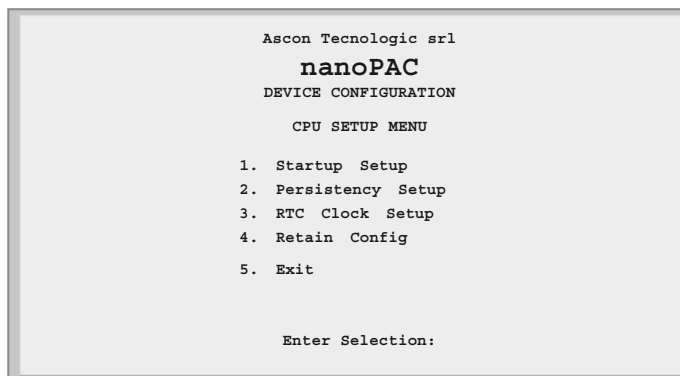

Figure 5.5 - CPU Setup Menu

Item	Description
Startup Setup	Startup Parameters
Persistency Setup	Persistency Parameters
RTC Clock Setup	Real Time Clock Settings
Retain Config	Retentive Registers Configuration
Exit	Return to previous menu

5-2-5 Startup Setup Menu

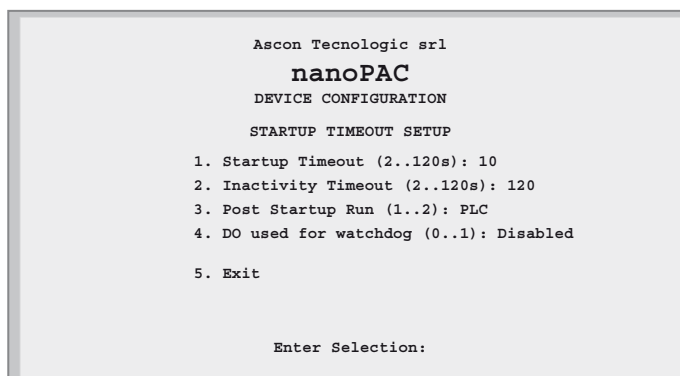

Figure 5.6 - Startup Setup Menu

Item	Description	Range	Factory Default
Startup Timeout	Timeframe window to enter the startup session	2... 120 (s)	10
Inactivity Timeout	Inactivity Timeout (please see 3-1-3 for details)	2... 120 (s)	120
Post Startup Run	Operation phase to be executed after the startup session	1... 2 [PLC/I/O Watch]	PLC
DO used for watchdog	Enabling of DO16 for watchdog management (if correctly configured)	0/1	Disabled
Exit	Return to previous menu	-	-

5-2-6 Persistency Setup Menu

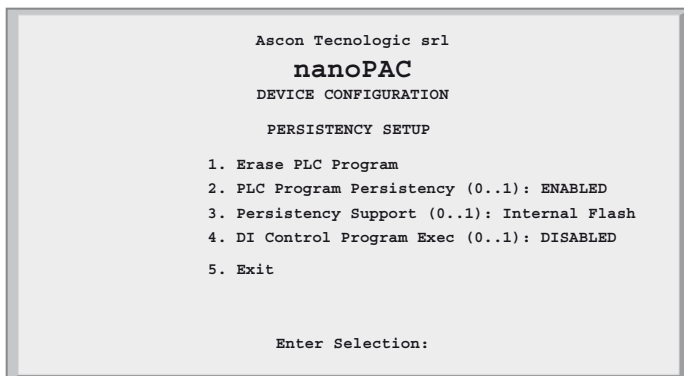

Figure 5.7 - Persistency Setup Menu

Item	Description	Range	Factory Default
Erase PLC Program	Command to erase the PLC program from flash memory	-	-
PLC Program Persistency	Function to save PLC program into flash memory	0/1 [Disabled/Enabled]	Enabled
Persistency Support	Media where to save copy of the PLC program	0/1 [Internal Flash/USB key]	Internal Flash
DI Control Program Exec	Reserves D01 for PLC program RUN/STOP function	0/1 [Disabled/Enabled]	Disabled
Exit	Return to previous menu	-	-

The CPU can save the PLC program into different persistent memory supports. Each time a new download of a program is executed by the developer, the CPU makes a permanent copy of it into the configured desired media for the next future executions. If needed, the selection of the “*Erase PLC program*” command will delete the PLC program from the media selected location: the overall time needed to perform the operation depends by the project size. Please wait until the “*Persistency setup menu*” screen reappears as confirmation for complete PLC program erasing.

5-2-7 RTC Clock Setup Menu

```

Ascon Technologic srl
nanopAC
DEVICE CONFIGURATION

CLOCK SETUP
1. Day of the Month: 15
2. Month: 9
3. Year: 18
4. Day of the Week: 5
5. Hour: 14
6. Minutes: 1
7. Seconds: 34
8. Refresh
9. Exit

Enter Selection:

```

Figure 5.8 - Clock Setup

Item	Description	Range	Factory Default
Day of the Month	Sets the day of the month number	0... 31	-
Month	Sets the month of the year number	1... 12	-
Year	Sets the last 2 digits of the year	2000... 2100	-
Day of the Week	Sets the day of the week number	1... 7 [Monday = 1]	-
Hour	Sets the Hour value	0... 24	-
Minutes	Sets the Minutes value	0... 59	-
Seconds	Sets the Seconds value	0... 59	-
Refresh	Command refreshing clock values	-	-
Exit	Return to previous menu	-	-

Note: The Real Time Clock values are not automatically refreshed by the system so, in case, select the “*Refresh*” to update.

5-2-8 Retain Config

```

Ascon Technologic srl
nanopAC
DEVICE CONFIGURATION

RETAIN CONFIG MENU

1. MB Slave 1 Split register (0..4096): 4096
2. MB Slave 2 Split register (0..4096): 4096
3. Simple Split byte (0..16384):16384
4. Exit

Enter Selection:

```

Figure 5.9 - Retain Config Menu

Item	Description	Range	Factory Default	Time to retain
MB Slave 1 Split register	Amount of Slave 1 Modbus agent retained registers	0... 4096	4096	10 ms
MB Slave 2 Split register	Amount of Slave 2 Modbus agent retained registers	0... 4096	4096	10 ms
Simple Split byte	Amount of generic memory retained bytes	0... 16384	0	15 ms
Exit	Return to previous menu	-	-	-

Standard and Retentive memory management The IEC 1131 programming tool allows to declare retentive variables using specific files and syntax. These variables are handled by a 32 kB size of MRAM memory (for security reasons, the memory is duplicated for redundancy and refreshed during runtime operations). Differently, it is possible to declare variables up to 32 kB in the % marker memory area (8192 Bytes for each Modbus slave agent).

The percentage memory locations, which can be also enabled to be retained by the above described function, are accessible by declaring the specific direct global variables from the OpenPCS IEC61131 environment programming tool.

In particular, the range available as retentive is:

Modbus Slave 1: %MW1128.0... %MW9320.0 (8192)
Modbus Slave 2: %MW10128.0... %MW18320.0 (8192)
Marker Area: %MB22000.0... %MB38384.0 (16384)

From the Device Configuration session, by the dedicated menu, it is possible to define the amount of registers/Bytes to be retained.

From the main menu select “CPU setup” -> “Retain Config”.

The “Retain Config” menu allows to define, for each specific item, the amount of data to be retained.

Note: The process which saves the retentive variables operates in parallel with the one of the PLC application. For this reason the cycle time of the whole project will be effected/delayed ONLY when it is lower than the overall time needed to save ALL the retentive variables defined!

- In case of “**Cold start**” command, the standard retentive variables will be reset or preset to the initialization value whereas the % retentive variables will be reset. In case of retain file corruption error, both the two memory areas are separately reset or initialized.
- In case of “**Warm Start**” command, if the PLC program has not been modified, both the standard and % retentive variables will remain to last previous values. In case of retain file corruption, the % retentive variables will be reset.
- In case of “**Hot start**” command, both the standard and % retentive variables will be unaffected.

It is possible to upload/download both type of retentive memory areas, standard and/or % variables, using a TFTP session. It is possible to perform this operation ONLY in the timeframe window available during the very first boot-up phase of the CPU, before the Device Configuration timeframe session. On how to perform the upload or download the specific retentive memory files, please follow the procedure described at paragraph: “Chapter 9 - CPU Configuration Software (TFTP File Access)” on page 49.

Publishing I/O configuration data, Battery and Retain Memory status While PLC program execution is possible to check and verify some specific CPU operational information, in particular:

%M0.0 : Battery status (1 = low, 0 = OK);
%M0.1 : Startup retain memory status (1 = corrupted, 0 = OK);
%M0.2 : Reserved;
%M0.3 : CPU Production Code status;
%M0.4 : EXP1 Production Code status;;
%M0.5 : EXP2 Production Code status;

The battery status is checked at Power ON and runtime. The remaining bits are updated at startup and the value remains unchanged after a warm or a cold startup.

5-2-9 Modbus TCP/IP Setup

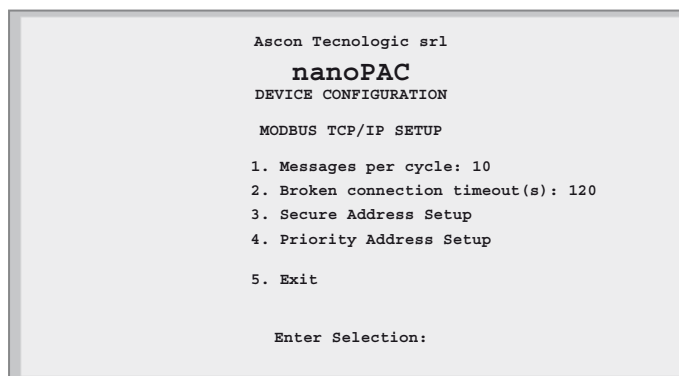

Figure 5.10 - Modbus TCP/IP Setup Menu

Item	Description	Range	Factory Default
Messages per Cycle	Max. number of processed messages per cycle	1... 50	10
Broken Connection Timeout	Inactivity Timeout of a TCP/IP connection	10... 5400 (s)	120
Secure Address Setup	Secure Address Setup Menu	-	-
Priority Address Setup	Priority Address Setup Menu	-	-
Exit	Return to previous menu	-	-

To verify the connection status after a long period of inactivity, is used the TCP/IP “keep alive” protocol. The protocol performs the following sequential steps:

1. At each received message the timeout is reset;
2. If timeout expires, a “test” message is sent in order to verify if the connection is still active;
3. If an answer to the “test” is received, then the timeout is reset;
4. In case of no answer, the “test” will be sent again three times, every 10 s;
5. If even after the fourth “test” nothing has been received, the connection will be closed.

5-2-10 Modbus TC/IP Secure Addresses Table Menu

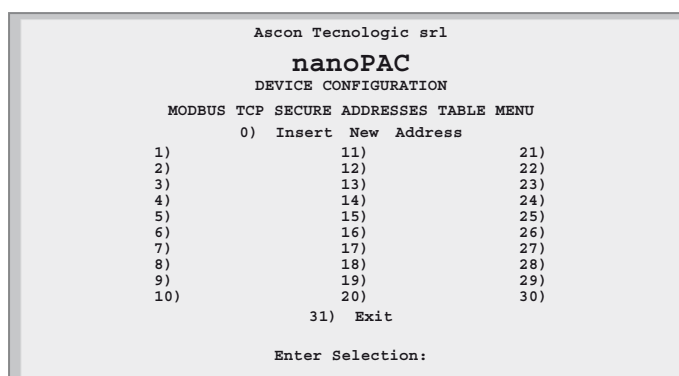

Figure 5.11 - Modbus TCP/IP Secure Addresses Table Menu

If the security function will be enabled (please see the “AT_Firmware_Lib Manual”), the list of addresses present in this menu will indicate the external Modbus TCP/IP Clients allowed to access the CPU Modbus TCP/IP server.

To add a new address, first select “0”, then enter the new one; it will be inserted in the first free position of the list. To delete an address, simply select the number of the list to be removed.

5-2-11 Modbus TC/IP Priority Addresses Table Menu

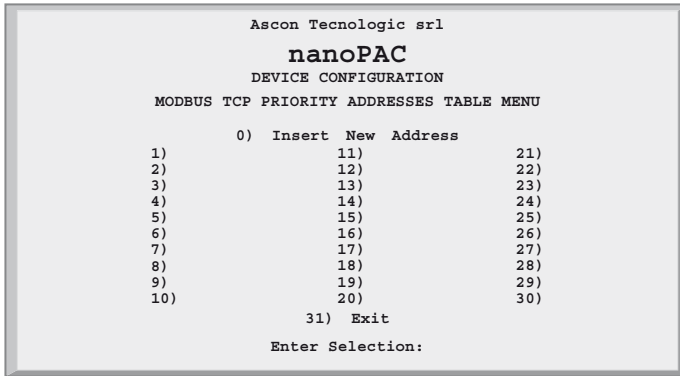

Figure 5.12 - Modbus TCP/IP Secure Addresses Table Menu

The rules to insert a desired value is the same just described above for the “Secure address table”. The addresses specified in the “Priority connection table” are managed in a very particular dedicated way because the Modbus TCP/IP server agent can sustain up to 10 TCP client simultaneous connections at the same time. So, when a new connection request is made, and all 10 available connections are already used, the system will close one of the active connections to satisfy the new request. Addresses not belonging to the “Priority connection table” will be closed as first, followed by those which have been inactive longest.

5-2-12 Local I/O Setup Menu

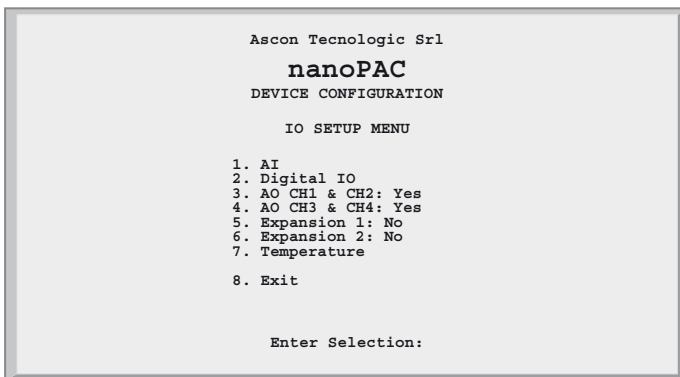

Figure 5.13 - I/O Setup Menu

Item	Description
AI	Universal Analogue Inputs configuration
Digital IO	Digital I/O Configuration
AO CH1 & CH2	Analogue Outputs 1 and 2 configuration
AO CH3 & CH4	Analogue Outputs 3 and 4 configuration
Expansion 1	1st Expansion Unit Configuration. Depending by the presence of an exPAC, a “Yes” or “No” tag indication will appear beside.
Expansion 2	2nd Expansion Unit Configuration. Depending by the presence of an exPAC, a “Yes” or “No” tag indication will appear beside.
Temperature	CPU Internal Temperature measures and°C, °F or K selection
Exit	Return to previous menu

5-2-13 Setting the AI Channels

Standard AI Menu

Select a
Standard AI
Channel

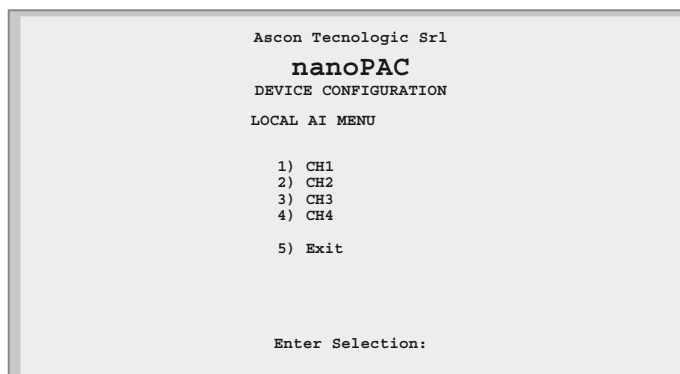

Figure 5.14 - Standard AI Selection Menu

Item	Description
Ch1	Analogue Input Channel 1 Configuration
Ch2	Analogue Input Channel 2 Configuration
Ch3	Analogue Input Channel 3 Configuration
Ch4	Analogue Input Channel 4 Configuration
Exit	Return to previous menu

Note: An additional channel is internally connected to a 5 Volts generator which must be connected to ratiometric sensors, therefore input 5 is always configured as output in Volts.

Setup the Selected AI Channel

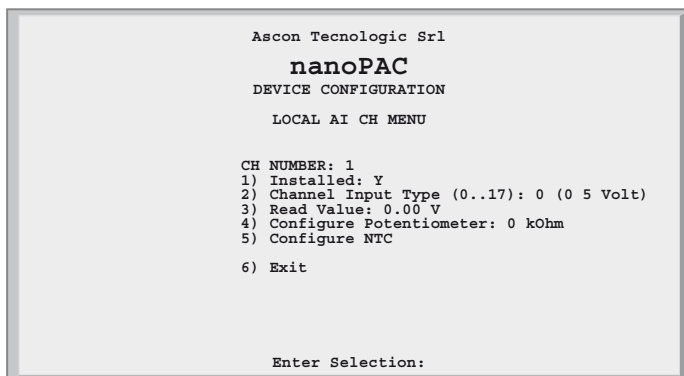

Figure 5.15 - Local Universal AI Setup Menu

Item	Description	Range	Factory Default
Installed	For the universal analogue inputs this item is always “Yes”	-	-
Channel Input Type	Analogue input type	0... 17	0 [0... 5 V]
Read Value	Forces to read the AI value	-	-
Configure Potentiometer	Defines the Potentiometer calibration value	0... 1000000	1000 [Ω]
Configure NTC	NTC configuration sub-Menu	-	-
Exit	Return to previous menu	-	-

Note: The corresponding configuration choices for all the 4 universal input channels is as described in the following table.

	Analogue Input Type		
	Value	Type	Range
Channel Input Type	0	0... 5 Volt	0.0... 5.5 V
	1	1... 5 Volt	0.6... 5.4 V
	2	0... 10 Volt	0.0... 11.0 V
	3	2... 10 Volt	1.2... 10.8 V
	4	0... 20 mA	0.0... 22.0 mA
	5	4... 20 mA	2.4... 21.6 mA
	6	Thermocouple J	-245.25... +1235.5°C
	7	Thermocouple K	-249.3... +1411.3°C
	8	Thermocouple L	-220.0... +620.00°C
	9	Thermocouple N	-32.5... +1332.5°C
	10	Thermocouple R	-40.0... +1640.0°C
	11	Thermocouple S	-44.0... +1804.0°C
	12	Thermocouple T	-215.0... +415.0°C
	13	PT100 (2 wires)	-232.3... +882.7°C
	14	PT1000	-232.3... +882.7°C
	15	Potentiometer	0... 1000000 Ω
	16	NTC SEMITEC 103AT-2	-56.5... +141.5°C
17	Ratiometric 5 V	0.0... 5.5 V	

*NTC custom
linearization
Menu*

```

Ascon Technologic Srl
nanoPAC
DEVICE CONFIGURATION
NTC MENU

out = a + b*(log)in + c(log)in*(log)in*(log)in
Measure Unit: °C
1) a: 0
2) b: 0
3) c: 0
4) Starting scale (°): 0
5) End of scale (°): 0
6) Under range: 188800
7) Over range (Ohm): 500
8) Use NTC Custom (Ohm): 0
9) Exit

Enter Selection:

```

Figure 5.16 - NTC custom linearization Menu

CH Number	Chosen Analogue Input Channel (Note)	Factory Default
A	Parameters for custom NTC linearization definition as temperature input probe. A, B, C are the Steinhart-Hart equation characteristic parameters necessary to perform the correct NTC linearization.	0
B		0
C		0
Starting scale	Temperature starting range value (in E.U.)	0
End of the scale	Temperature final range value (in E.U.)	0
Under range (Ohm)	Probe resistance value for under range	188800
Over range (Ohm)	Probe resistance value for over range	500
Use NTC Custom (0... 1)	Selection of calculation type	0 (Disabled)
Exit	Return to previous menu	-

Note: The setup menu for the 4 Universal input channels set as NTC custom is the one just described in the above table.

5-2-14 Analogue Output Ch1 - Ch2 or Ch3 - Ch4 Menu

```

Ascon Technologic Srl
nanoPAC
DEVICE CONFIGURATION
LOCAL AO CH1 & CH2 MENU

1) CH1
2) CH2
3) ENABLED: Yes
4) Exit

Enter Selection:

```

Figure 5.17 - AO Ch1 - Ch2 or Ch3 - Ch4 Menu

Item	Description
CH1 (CH3)	Analogue Output Channel 1 (or 3) Configuration
CH2 (CH4)	Analogue Output Channel 2 (or 4) Configuration
Enabled	“Yes” if optional Analogue Output Channels 1 & 2 (or 3 & 4) are present
Exit	Return to previous menu

AO Channels Setup Menu Please note that for all 4 optional output channels the setup menu is the same as described here.

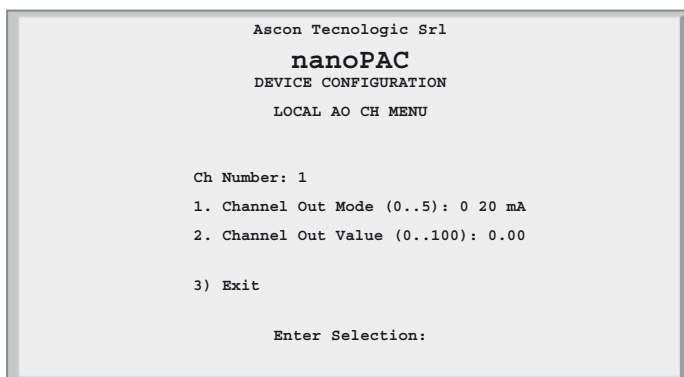

Figure 5.18 - AO Setup Menu

Ch number	Chosen Analogue Output Channel (Note)	
Channel Out Mode	Analogue Output Type	
	Value	Type
	0	0... 5 Volt
	1	1... 5 Volt
	2	0... 10 Volt
	3	2... 10 Volt
	4	0... 20 mA
5	4... 20 mA	
Channel Out Value	Used to set temporary the analogue output value: please note that the range of the value is 0... 100% for single polarity signals	
Exit	Return to previous menu	

5-2-15 Internal Temperature Menu

To acquire the internal temperature, the nP4 CPU is equipped with a thermistor. The value can be read from the specific “*Temperature Menu*”.

```

Ascon Tecnologic Srl
  nanoPAC
DEVICE CONFIGURATION
  TEMPERATURE MENU
Temperature 1: 31.6

1. T1 Unit (0..2): Celsius
2. Read T1
3. Refresh
4. Exit

Enter Selection:

```

Figure 5.19 - Temperature Menu

Temperature 1	Measured temperature of the internal electronic board	
T1 Unit	Measure Unit used for T1	
	Possible values are:	
	Value	Type
	0	Celsius
	1	Kelvin
2	Fahrenheit	
Refresh	Refresh the displayed values T1	
Exit	Return to previous menu	

5-2-16 CPU Info Menu

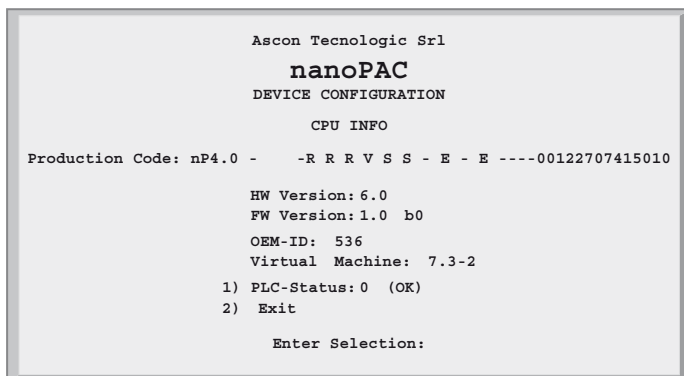

Figure 5.20 - CPU Info

	Status	Message
Production Code (factory reserved information)	OK	The system displays the production code (as shown)
	Error	The system displays the message: Code Info Error - Invalid File (note)
HW Version	Revision of the CPU hardware	
FW Version	Revision of the CPU firmware	
OEM-ID	Ascon Tecnologic ID code for the runtime system	
Virtual Machine	Version of the runtime software	
PLC-Status	CPU Status Indication and acknowledge of the errors	
	Errors bit mask (valid also combination of them)	
	bit	Meaning
	0	Configuration file CRC error
	1	Retain Variables file error (only at boot up)
	2	Battery level Low error
	3	Flash Fat file System error (at boot up)
4	Calibration file CRC error (at boot up)	
Exit	Return to previous menu	

Note: Active errors are acknowledged by entering **1** and the **Return** key while displaying the “CPU Info” screen.

Chapter 6

USB Mass Storage Device

6-1 Configuring the CPU with the USB Mass Storage Device

The nP4 CPU is equipped with an USB port type AB which can operate in Host mode and manage an USB Mass Storage Device (**USB key**) to download/upload the CPU firmware or some specific system files. Both processes have their own specific procedure and cannot take place together due to a specific sequence of actions.

6-1-1 Boot-up sequence

The following flowchart illustrates the various steps performed by the CPU while powered up until the timeframe window to access the system configuration session (via a Telnet client such as the Windows Hyperterminal).

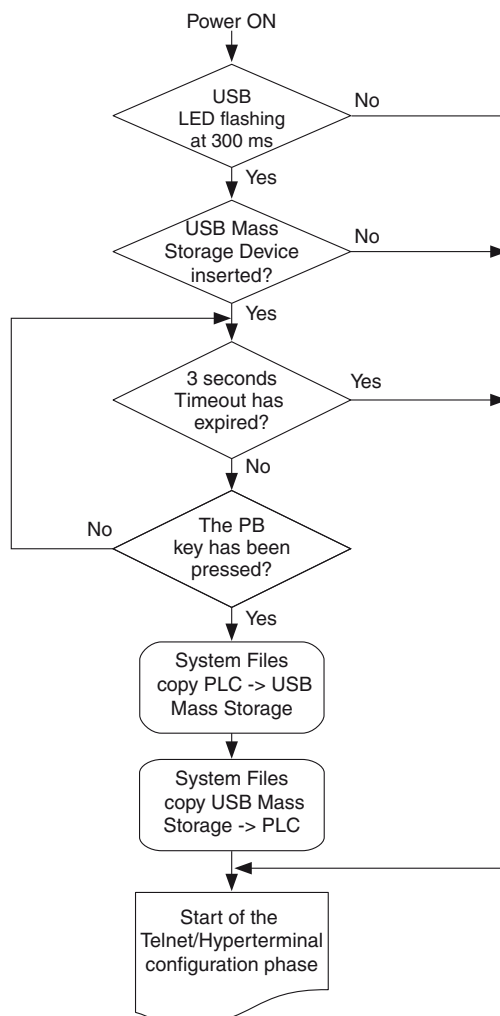

6-1-2 Upload of the files involved within the PLC program operations

After the boot-up phase, if the above described procedure has been properly executed, the CPU copies the internal files on the USB key (if present) as follows.

File location in the PLC	File location in the USB key
/A/restore_file	0:sys_sts/apl_rest.bin
/A/sys_file	0:sys_sts/sys_conf.bin
/A/errlog_file	0:sys_sts/err_log.bin
/fs2/retain	0:sys_sts/ret_var.bin

Note: “0:” identifies the drive letter assigned to the USB key by the File System.

6-1-3 Download of the files involved within the PLC program operations

Once the files upload process described at paragraph 6.1.2 has ended, the CPU copies then the same files but from the USB key (if present) to the internal Flash memory.

File location in the USB key	File location in the PLC
0:cnfg_sys/apl_rest.bin	/A/restore_file
0:cnfg_sys/sys_conf.bin	/A/sys_file
0:cnfg_sys/ret_var.bin	/fs2/retain

Note: “0:” identifies the drive letter assigned to the USB key by the File System.

6-1-4 File system support for the CPU application

Application file executed by the CPU

The program executed by the CPU may reside in the internal Flash file system or in the USB key. The memory support where to save the program can be selected in the “**Persistency Menu**” available from the Setup configuration session.

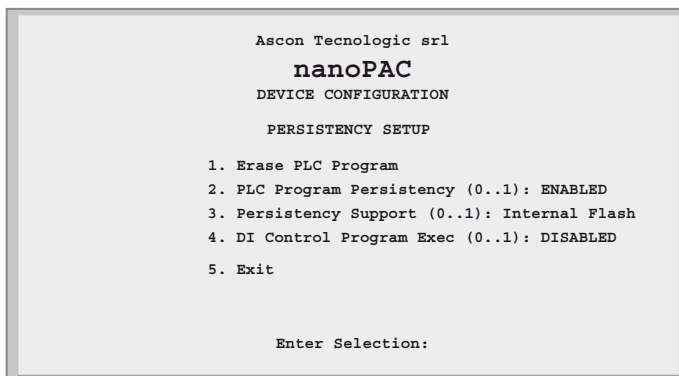

Figure 6.1 - Persistency Setup Menu

Through the “Persistency Support” parameter the user can select the area where a persistent copy of the PLC program will be saved.

If the user sets the parameter “Persistency Support” to “0”, the program will be saved in the CPU Internal Flash Memory whilst setting the value to “1” it will be saved in the USB Key.

If the user selects to save the PLC application in the USB Key, the path where the program file will be saved is:

0:applic/res_file.bin

If the user selects to save the PLC application in the Internal Flash memory, the path where the program file will be saved is:

/A/restore_file

Application file generated by OpenPCS

The binary application file generated by OpenPCS (standard IEC61131 compliant) which can be downloaded via TFTP to the CPU is located in the “\$GEN\$/Resource” directory of the specific project. The procedure to download it is the following:

- Open a tftp client, set the IP address and port (69) of the device you want to connect;
- Execute a “**put**” command where the source file name will be:
`project_root/GEN/Resource/Resource.prs`
while the name of the output file will be:
`/A/restore_file`
for the Flash file system, or
`0:applic/res_file.bin`
for the USB Key.

Chapter 7

CPU Diagnostic Tests

7-1 Accessing the diagnostic session

Included into the Telnet Configuration session, the **nP4** unit provides a specific diagnostic interface which allows the user to check and test the on-board I/Os. It can be activated from the “STARTUP TIMEOUT MENU”, by using the entry “**Post Startup Run**”.

```
Ascon Technologic srl
nanoPAC
DEVICE CONFIGURATION
STARTUP TIMEOUT SETUP
1. Startup Timeout (2..120s): 10
2. Inactivity Timeout (2..120s): 120
3. Post Startup Run (1..2): PLC
4. DO used for watchdog (0..1): Disabled
5. Exit

Enter Selection:
```

Figure 7.1 - Startup Setup Menu

To run the “*Diagnostic Watch Window*”, the value “*I/O Watch*” must be set to value “**2**”. The table that follows displays the possible values for the “*Post StartUp Run*” entry:

Value	Value displayed	Meaning
1	PLC	Exiting the configuration session the system runs the PLC 1131 application
2	I/O Watch	Exiting the configuration session the system runs the I/O Watch Window

When the user exits the configuration session, the system restarts running the selected option.

7-2 I/O Watch Window

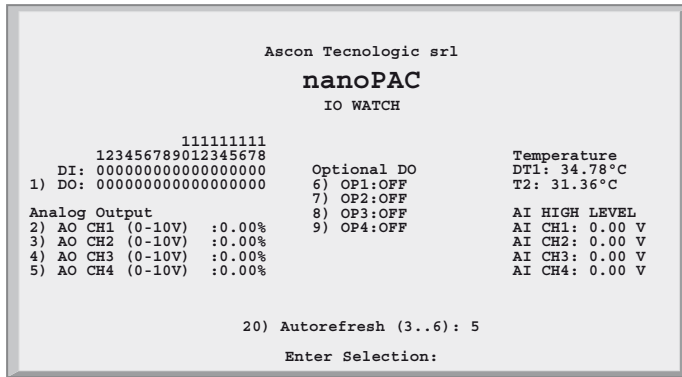

Figure 7.2 - I/O Watch Window

From the “I/O Watch Window” the user can:

- Read the analogue input values in engineering format;
- Read the digital input values as bit mask;
- Display/Set the analogue output values in percentage (0...100);
- Display/Set the digital outputs as bit mask;

The window is updated continuously and allows the user to check the I/O present on-board. The refresh rate can be adjusted accordingly to the following table:

Value	Refresh rate
0	No refresh (static mask)
1... 5	Refresh Time Value (1... 5 seconds)

To set an output value, the user must select the desired specific one (1 for the DOs, 2... 5 for the AOs or 6...9 for relay/SSR drive) and then specify the desired value:

- A percentage (0...100%) for the analogue (without regard for the output type);
- A Boolean value for the digital or OPs.

Examples: **Digital Output Channels**

Digital Output	DO1	DO2	DO3	DO4	DO5	DO6	DO7	DO8
Desired value	0	0	1	0	0	0	1	1
Enter selection	1							
Insert new value	00100011							

Analogue Output Channels

- Ch1 Output Type:**0... 10 V
Desired value:7.00 V
Enter selection:2
Insert new value:70.00
- Ch2 Output Type:**4... 20 mA
Desired value:12 mA
Enter selection:3
Insert new value:50.00

In order to exit the I/O atch Window mode, reboot the CPU and change the related specific option (see “Startup Setup Menu” on page 27)

Chapter 8

Programming the CPU

8-1 Installing OpenPCS

8-1-1 Hardware and Software Requirements

To properly install and operate with the OpenPCS programming tool version 7.x is required a PC equipped with at least:

- An Intel® Core™ i5 Processor, 2.30 GHz;
- 4 GB RAM;
- 16 GB of free disk space;
- A minimum resolution of 1024 x 768 resolution;
- Windows 7 or 8.1 or 10 (32 or 64 bit).

8-1-2 Installation

The programming tool is provided within the AT Automation Suite. If natively supported by your PC and Internet browser, an HTML main screen interface could be automatically started and from where you can select the software version you want to install. If the auto-start function is disabled or the software comes as standalone package on an USB key or via web, please start the last distributed available OpenPCS programming tool version (e.g. OpenPCS_Ver_713e.exe file) available in X:\SETUP\ folder ("X": is the letter assigned to the CD-ROM or USB drive by your PC).

At the end of the installation, a popup window will ask if you want to install also an hardware driver. If the drivers have been provided within the AT Automation Suite, please select the desired one to be installed, otherwise select "**Quit**".

The driver file (.cab) typically includes everything needed to fully operate with the OpenPCS programming tool: hardware drivers, libraries, specific documentation, customized functions and the annual licenses related to the AT hardware platforms. In case of need to enter manually the license codes, please see Licence Editor for how to insert them. If you do not have a hardware driver or a valid active license key, OpenPCS will be 100% functional but with all the restrictions of the "*SIMULATION*" mode.

8-1-3 Starting OpenPCS

Start Windows and from the start-menu choose:

Start → Programs → infoteam OpenPCS 7.x → infoteam OpenPCS 7.x
or double click on the specific desktop icon to open the Framework.

8-1-4 Configuring OpenPCS

In order to work with the Ascon Tecnologic CPU target and the OpenPCS programming tool, you must have first installed cab file. The file `AT_sigmaline_zzzz.cab` includes ALL the files inherent the **sigmaline** Hardware, drivers, examples and utilities (`zzzz` are digits to identify the year of the software release).

In case of manual or additional cab file installation, from the OpenPCS “Extras” menu, select “tools – Driver install...”. Then, from the following popup window “Select” the desired cabinet (e.g. `AT_sigmadue_2012.cab`) and finally “Install”.

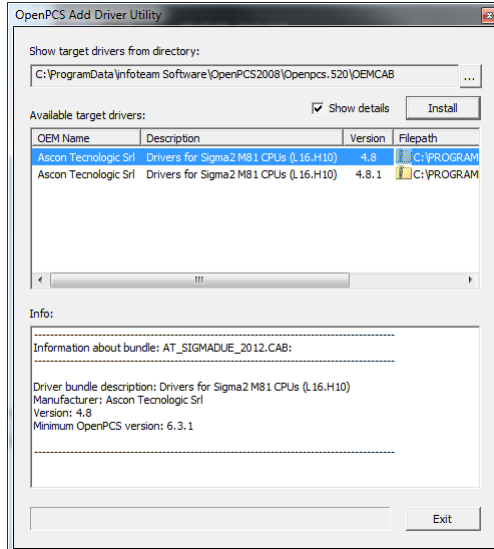

Figure 8.1 - OpenPCS OEM Driver Installation

8-2 OpenPCS Setup

In order to establish the communication between the OpenPCS programming tool and an Ascon Tecnologic target (hardware platform), a connection should be defined. The installation procedure creates itself a connection.

In case of need to modify or create a new one, select the “Connections...” item in the “PLC” menu then, from the popup window “Connection Setup” select “New”.

Now, from the window “Edit connection” it is possible to create the new connection and from the field “Name” you can assign a desired name to the connection.

By pushing the “Select” button you can pick the driver that manages the communication with the target: for Ascon Tecnologic CPUs is TCP52.

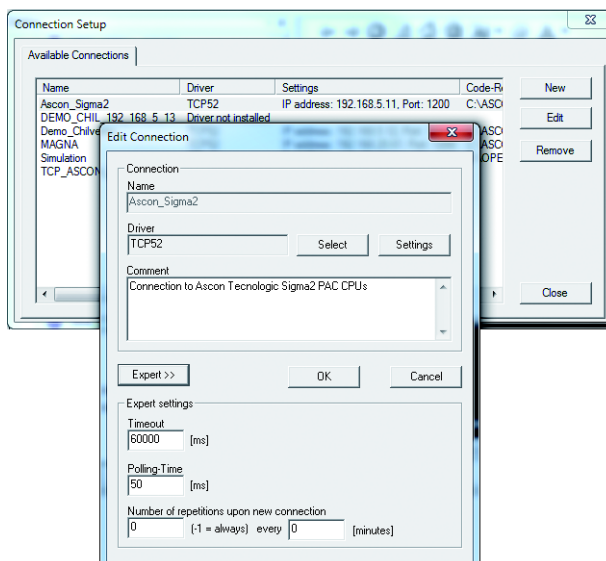

Figure 8.2 - OpenPCS Connection Setup

Now, click “Settings” button to set the communication parameters.

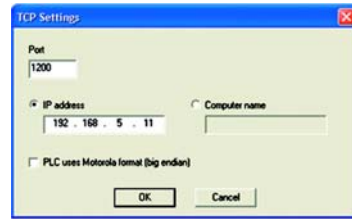

Figure 8.3 - TCP Settings

The Port number and IP address must be the same as those configured from the initial CPU configuration session. See the Ethernet setup menu, items 2 and 7 (see “Figure 5.3 - Ethernet Setup Menu” for details).

OpenPCS environment is now ready to communicate with the Ascon Tecnologic target.

The project must be setup in order to use the CPU: select the “Resource Properties” item in the PLC menu, select “Ascon...” in the “Hardware Module” field, then select the newly created TCP connection in the “Network Connection” field.

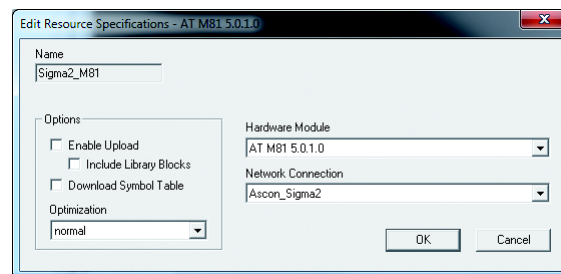

Figure 8.4 - OpenPCS resource Specifications

The “Optimization” option menu allows to select between three compilation choices: two of them, “Normal” and “Speed only”, are referred to the usage of the NCC (Native Code Compiler) to increase the overall performances of the PLC application whilst the “Size only” options can be used to minimize application memory usage.

Please note that in case of NCC usage it is not allowed to insert break points while debugging the projects.

Setup Communication Timeout

There are several conditions that could make necessary to set the Ethernet Port communication timeout to an higher value than default. This timeout verifies the connection status between OpenPCS and the target CPU: for example, in case of need to transfer a big size project, due to the amount of time to perform the operation, it may be necessary to set a longer driver timeout. The default value of 5000 ms can be increased by using the connection “Expert” mode option (suggested value = “30000” which means a 30 seconds timeout).

8-3 Watchdog Timer

The Ascon Tecnologic nP4 can perform a watchdog control which operates accordingly to 2 specific FBs (WATCHDOG_SET and WATCHDOG_STATUS).

Conceptually, the Watchdog is a countdown timer which is reset by the CPU every program cycle: if the count reaches value zero, two different operational modes may be set:

- The CPU continues, if possible, the program execution, stores the event and, if enabled, activates the dedicated DO (please see “5-2-5 Startup Setup Menu” for details);
- The CPU resets (power cycles) to restart the program;

- The CPU stops the 1131 application and activates the specific configured DO. Please note that the Watchdog timer is controlled by FBs and it runs independently from the PLC program. Therefore, if the program stops, the timer is still active and behaves as programmed when the counter reaches zero.

Chapter 9

CPU Configuration Software (TFTP File Access)

9-1 TFTP Protocol Access

The **sigmaline nP4** unit allows the user to access the internal device file system using a TFTP (Trivial File Transfer Protocol) client.

All the Internal Flash Memory files present in the CPU and on the USB Key, can be reached by the TFTP protocol through an Ethernet connection (**port 69**), including the custom ones related to the PLC data logging.



Caution

Working with large files on the USB key will produce an overall decreasing of the CPU performances which would have a significant impact on the whole application cycle time. **For this reason, it is STRONGLY recommended to not exceed 120 MB maximum as data - logging file dimension!**

With TFTP protocol it is possible to upload/download the Firmware, device configuration, IEC61131 program, retained variables and log files to/from the PLC. For security reasons, the name and the number of the accessible files is limited and fixed. The following table lists the Internal Flash Memory accessible files:

File Name	Description
/A/restore_file	IEC61131 program file name
/A/sys_file	Configuration file
/A/errlog_file	RUNTIME errors file name
/fs2/retain	Classic and % retained variable file name
/fs2/stop_prg	Stops the PLC program (note 1)
/fs2/run_prg	Starts the PLC program (1)
/fs2/erase_prg	Erases the PLC program (1)
/fs2/ack_alm	Acknowledges the retentive variables file error alarm ONLY (2)
/fs2/reset	Reset command file (note 3)

- Notes:**
1. The TFTP commands do not produce any errors feedback because they do not establish real TFTP data exchange.
 2. Because the Acknowledge command cannot be retained, it is not possible to use it for all the other CPU alarm status. To acknowledge those ones you have to use the standard procedure as described in "CPU Info Menu" on page 38.
 3. This TFTP command does not get any feedback answer from the CPU because it resets itself.

**Caution**

The **Reset Command file** (*/fs2/reset*) activates the CPU reset command. The access to the */fs2/reset* file using the TFTP connection causes the instantaneous reset of the CPU.

To connect the unit, the user needs to know the device IP address (see “Ethernet Setup Menu” on page 26 for details) and the logic port used, which is always **69** for the TFTP activities. The TFTP protocol has only two different services:

- GET (upload)
- PUT (download)

The GET service allows the user to upload a file from a CPU unit whilst the PUT allows files to be downloaded. Using the TFTP client available with Windows (see *C:\Windows\System32\tftp.exe*) the syntax to be used for the commands are:

- To GET a file from the nP4
`tftp -i <remote host address> get <remote file_name><local file name>`
- To PUT a file into the nP4
`tftp -i <remote host address> put <local file name><remote file_name>`

For example, if the user wants to GET the configuration file from a CPU unit, and store it in a local file named “configuration.bin”, the command is:

```
tftp -i 192.168.5.11 get /A/sys_file configuration.bin
```

where 192.168.5.11 is the CPU IP address.

If the user wants to PUT the IEC61131 program file into a CPU unit, using the source file “*sigmaline_nP4.prs*”, the command will be:

```
tftp -i 192.168.5.11 put sigmaline_nP4.prs /A/restore_file
```

Please note that the application binary file which contains the program compiled with OpenPCS is located in the project folder “project_root/\$GEN\$/Resource” and has always an extension file name “*.prs”.

9-2 IEC61131-3 OpenPCS Runtime Errors log file

In all those situations where an unpredictable internal error locks the CPU, it is very useful to have an historical file which lists and memorizes them, organized by date and time and that can help somehow to understand or identify the source of it. For this reason, it is available into the CPU unit, a file called */A/errlog_file* that can be uploaded. It is a text file (can be opened by Windows Notepad, for example) and it is organized in rows. The history goes back to maximum 10 events and it is organized as:

```
day of the weekhh:mm:ssdd-mm-yyerror code
```

Following an example:

```
Wed16:37:2823-04-122002  
Wed16:37:2523-04-122002  
Wed16:36:3623-04-122001  
Thu 11:56:2922-04-122002
```

The table of error managed is the following:

Code	Name	Description
0	kLzsSuccess	PLC is working normal
1	kLzsGeneralError	GENERAL ERROR!
1001	kLzsModeConflict	Local Run/Stop-Switch on PLC set to <STOP>
1002	kLzsNoMem	Out of program memory: program execution not possible
1003	kLzsHardwareError	Hardware error
1004	kLzsInvalidPgm	No valid program
1005	kLzsDwnldError	Download of invalid data
1006	kLzsConfigError	Configuration error/wrong program
1007	kLzsInvalidModCfg	Module configuration error
1008	kLzsInvalidPgmNr	Invalid program number
1009	kLzsInvalidSegNr	Invalid segment number
1010	kLzsInvalidSegType	Invalid segment type
1011	kLzsSegDuplicate	segment already on PLC
1012	kLzsNoWatchTabEntry	No free watch ID available
1013	kLzsUnknownCmd	Invalid command received
1014	kLzsModeErr	Action not valid. Wrong mode
1015	kLzsNetError	General network error
1016	kLzsNetRecSizeError	accepted receipt too small
1017	kLzsProclmgRdWrError	Error reading/writing process image
1018	kLzsTimerTaskError	Timertask error
1019	kLzsIpVerError	Wrong kernal version
1020	kLzsIpExecError	Error calling kernal
1021	kLzsNcExecError	Error calling native code
1022	kLzsNoBkupMem	Out of backup memory (EEPROM/Flash): program will be lost on power down
1023	kLzsIOConfigError	Error in I/O-Configuration
1024	kLzsNoHDMem	Out of user disk space: download of raw file failed
1025	kLzsNotValidInRunState	Invalid action-switch PLC to stop first
1101	kLzsCycleLengthExceeded	RUNTIME ERROR: cycle length exceeded
1102	kLzsRtxBaseTimerLengthExceeded	RUNTIME ERROR: RTX Base Timer length exceeded
1103	kLzsNetErrorLastSession	The previous Online Session was interrupted unexpectedly
1104	kLzsUpIErrorNotEnabled	UPLOAD ERROR: Resource does not containupload information
1105	kLzsHistNoFreeEntry	No free hist ID available
1106	kLzsHistInvalidID	Invalid hist ID
1201	kLzsRawFileWriteError	Writing of Raw File failed (disk full write protected etc.)
1202	kLzsRawFileReadError	Reading of Raw File failed (file does not exist, no permission etc.). Try to download again.
1203	kLzsRawFileDeleteError	Deleting of Raw File failed (file is r/o no permission etc.)
1501	kLzsNetInitError	Network configuration error
1502	kLzsNetIoError	Network error in IO-Process communication
1503	kLzsNetInvalidNodeID	Invalid Node Address selected for this PLC
1504	kLzsNetVarCfgError	Invalid configuration for Network Variables (incorrect DCF)
1505	kLzsNetNIOOverflow	Network Image overflow (too many network variables defined)
1506	kLzsNetInvalidIpCfg	Invalid IP configuration selected (MAC Addr., IP Addr. or Subnet - Mask)

1507	kLzsNetRemoteNodeCfgError	Remote Node configuration error for details see Error Logfile
1508	kLzsNetErrorInOfflineMode	A network error was occurred during the PLC offline state
1601	kLzsNoBreakpointError	No breakpoint
1602	kLzsMaxBreakpointsError	Maximum number of breakpoints reached
1603	kLzsBreakpointNotFound	Breakpoint not found
1604	kLzsDwlTDTError	TDT error
1605	kLzsMoveSegmentError	Error moving segment
1606	kLzsDwlNoLinkerTableError	Linker table error
1607	kLzsDwlAlignmentError	Alignment error
1608	kLzsDwlDSSizeError	DS size error
1609	kLzsDwlReadSegAddrError	Error reading segment address
1610	kLzsDwlResourceReplaceError	Resource replace error
1611	kLzsDwlNoSegTabError	No segment table
1612	kLzsDwlProcDataError	Download procd data error
1613	kLzsDwlNoCopyTableError	No copy table
1614	kLzsHistMaxHistError	Maximum number of history entries reached
1615	kLzsHistSizeError	Historical data size error
1616	kLzsHistMutexError	Historical data mutex error
1617	kLzsHistMaxHistSettingError	LZS_MAXHIST is set too high
1618	kLzsForceTypeError	Unsupported force type
1619	kLzsWatchTypeError	Unsupported watch type
1620	kLzsWatchDeleteError	Error deleting watch entry
1621	kLzsInterpreterError	Interpreter error
1623	kLzsProclmgError	Process image error
1624	kLzsLoginStatusError	Status error on login
1625	kLzsLogoutStatusError	Status error on logout
1626	kLzsWriteSegAddrError	Error writing segment address
1627	kLzsSaveTempSegError	Error saving temporary segment
1628	kLzsNccExecFrmwFnctError	NC firmware execution error
1629	kLzsNccStubError	Undefined stub called in native code
1630	kLzsIStackError	Instance stack overflow
1631	kLzsIStackError2	Instance stack underflow
1632	kLzsPersCRCFailed	CRC Error reading persistence.
1633	kLzsPersVersionMismatch	Version mismatch between target system and persistence
1634	kLzsPersSaveError	Saving persistence failed!
1635	kLzsMaintenanceModeErr	No maintenance mode !
1636	kLzsDwlPISizeMismatchError	Process image size changed
1637	kLzsPatchDirFarByrefError	Error patching Direct Far Byref
1638	kLzsPersCapsMismatch	Capability mismatch between target system and persistence
1639	kLzsEventTaskTwice	Event task exists twice
1700	kLzsRedBackupModeErr	Action not allowed on Backup system
2001	kIpDivisionByZero	RUNTIME ERROR: division by zero
2002	kIpArrayIndexInvalid	RUNTIME ERROR: invalid array index
2003	kIpOpcodeInvalid	RUNTIME ERROR: invalid opcode
2004	kIpOpcodeNotSupported	RUNTIME ERROR: opcode not supported
2005	kIpExtensionInvalid	RUNTIME ERROR: invalid extension
2006	kIpTaskCmdInvalid	RUNTIME ERROR: unknown command
2007	kIpPflowNotAvailable	Kernel without power flow

2008	klpInvalidBitRef	Invalid bit reference
2009	klpErrorRestoreData	Error restoring data
2010	klpNoValidArrElementSize	Invalid array element size
2011	klpInvalidStructSize	Invalid struct size
2012	klpModuloZero	RUNTIME ERROR: modulo zero result undefined
2013	klpArrElemNotSupported	Arrays of this type not supported
2014	klpMemMonitorError	Memory Monitor detected critical error!
3001	klecGeneralError	FIRMWARE: general error. Group: ID:
3002	klecFBNotSupported	FIRMWARE: called FB not available. Group: ID:
3003	klecHardwareError	FIRMWARE: error accessing the hardware. Group: ID:
9002	kLzsOemError02	Not enough space in backup memory: retentive variable will not be saved
9003	kLzsOemError03	Not enough space in persistent memory
9004	kLzsOemError04	Hard fault occurred
9005	kLzsOemError05	Runtime event: watchdog timeout expired

Error 0 and Error 1103 are not saved because it is generated every time the application restarts from a previous error situation. The errors log file is generated in FIFO mode (First In First Out).

Chapter 10

CPU Data Memory Map

A **sigmaline nP4** CPU is a very flexible unit equipped already with several onboard I/O channels that can be easily accessed by specific dedicated memory map area. The memory areas are divided into different sections:

Central Unit	Digital Input Status
	Analogue Input Value
	I/O Diagnostic Status
	Onboard Temperature Values
	Digital Counters
	Digital Output Status
	Analogue Output Value
Expansion Units (1 & 2)	Expansion Unit Digital Input Status
	Expansion Unit Analogue Input Value
	Expansion Unit I/O Diagnostic Status
	Expansion Unit Onboard Temperature Values
	Expansion Unit Digital Counters
	Expansion Unit Digital Output Status
	Expansion Unit Analogue Output Value



Caution

Please check the **nP4** Ordering Code to verify the available options of your device.

10-1 Central Unit Data

10-1-1 Standard & Special Digital Inputs Status (D01... D16, CNT1 & CNT2)

All the 16 Digital I/O channels present on the CPU can be configured as Digital Input whilst the operative mode of 2 ones for the fast counters is fixed.

The status of all of them can be derived from 2 specific word data type, at addresses:

Addr..	Memory type	Size [Bytes]	Data type	Data
320.0	%I	2	WORD	Standard DI status
324.0	%I	2	WORD	Special DI status
327.7	%IX	1	BIT	PB button status

Note: The WORD are organized as a bit mask (xx.0... xx.15) where the DI1... DI16 input status are mapped while the status of the button present on PLC upper side is mapped directly as single bit (called PB as “Push Button”).

In case of Special DI configured as Fast Pulse Counters, the data are organized in a different way and the accumulated values are mapped on 2 different memory areas for each channels.

The data format used for them is the Unsigned Integer (UDINT) 16 bit.

Addr..	Memory type	Size [Bytes]	Data type	Data
220.0	%I	2	UINT	CNT1 Pulse Counter
222.0	%I	2	UINT	CNT1 no. of Counter overflows
224.0	%I	2	UINT	CNT2 Pulse Counter
226.0	%I	2	UINT	CNT2 no. of Counter overflows

10-1-2 Universal Analogue Inputs (AI1... AI4)

The 4 Universal Analogue Inputs are always present on the device. The inputs Configuration is performed using the CPU Configuration Session (see Chapter 4 for details) or tools. The values present in the memory map are already expressed in engineering unit (V, mA, mV, ° or Ohm), using a REAL 32 bit floating point notation, at the following addresses.

Addr..	Memory type	Size [Bytes]	Data type	Data
140.0	%I	4	REAL	AI value Channel_1
144.0	%I	4	REAL	AI value Channel_2
148.0	%I	4	REAL	AI value Channel_3
152.0	%I	4	REAL	AI value Channel_4

These 4 Universal Analogue Inputs can be configured as:

Value to be inserted in configuration Menu	Range selected
0	0... 5 Volt
1	1... 5 Volt
2	0... 10 Volt
3	2... 10 Volt
4	0... 20 mA
5	4... 20 mA
6	Thermocouple J
7	Thermocouple K
8	Thermocouple L
9	Thermocouple N
10	Thermocouple R
11	Thermocouple S
12	Thermocouple T
13	PT100 (2 wires)
14	PT1000
15	Potentiometer
16	NTC SEMITEC 103AT-2

The raw values of the above described inputs can be found at addresses:

Addr..	Memory type	Size [Bytes]	Data type	Data
20.0	%I	4	REAL	AI raw value Channel_1
24.0	%I	4	REAL	AI raw value Channel_2
28.0	%I	4	REAL	AI raw value Channel_3
32.0	%I	4	REAL	AI raw value Channel_4

10-1-3 I/O Diagnostic Status

For each analogue channel (Input and Output), the **nP4** unit provides an indication about the operational status of the channel (even if this is not present because optional).

The possible values of this indication are as follows:

Status Value	Description
0	The value is in the range of the signal
1	The value is under range of the signal
2	The value is over range of the signal
4	Channel not Configured
8	No valid measure available

Memory map for the input diagnostic indications:

Addr..	Memory type	Size [Bytes]	Data type	Data
80.0	%I	1	BYTE	AI Status Channel_1
81.0	%I	1	BYTE	AI Status Channel_2
82.0	%I	1	BYTE	AI Status Channel_3
83.0	%I	1	BYTE	AI Status Channel_4

Memory map for the output diagnostic indications:

Addr..	Memory type	Size [Bytes]	Data type	Data
100.0	%I	1	BYTE	AO Status Channel_1
101.0	%I	1	BYTE	AO Status Channel_2
102.0	%I	1	BYTE	AO Status Channel_3
103.0	%I	1	BYTE	AO Status Channel_4

Memory map for the Standard & Special Digital Input diagnostic indications:

Addr..	Memory type	Size [Bytes]	Data type	Data
110.0	%I	1	BYTE	Status Digital Channels
111.0	%I	1	BYTE	Status CNT1 Channel
112.0	%I	1	BYTE	Status CNT2 Channel

10-1-4 Internal Temperature Values

The **nP4** unit provides an indication about the internal temperature of the device.

The data format used for the value present in the memory map is a REAL 32 bit floating point notation in engineering unit (°C, °F or K).

Addr..	Memory type	Size [Bytes]	Data type	Data
0.0	%I	4	REAL	Cold Junction Temperature Value
4.0	%I	4	REAL	Internal CPU Temperature Value

10-1-5 Digital Software Counters

In the Configuration session (please see “5-2-5 - Startup Setup Menu” on page 27 for details) it is possible to enable a Counter function for each digital defined as input. In memory map, there is a section where all Counters value are available.

The data format used for them is the Unsigned Double Integer (UDINT) 64 bit.

Addr..	Memory type	Size [Bytes]	Data type	Data
240.0	%I	4	UDINT	Counter Channel_1
244.0	%I	4	UDINT	Counter Channel_2
248.0	%I	4	UDINT	Counter Channel_3
252.0	%I	4	UDINT	Counter Channel_4
256.0	%I	4	UDINT	Counter Channel_5
260.0	%I	4	UDINT	Counter Channel_6
264.0	%I	4	UDINT	Counter Channel_7
268.0	%I	4	UDINT	Counter Channel_8
272.0	%I	4	UDINT	Counter Channel_9
276.0	%I	4	UDINT	Counter Channel_10
280.0	%I	4	UDINT	Counter Channel_11
284.0	%I	4	UDINT	Counter Channel_12
288.0	%I	4	UDINT	Counter Channel_13
292.0	%I	4	UDINT	Counter Channel_14
296.0	%I	4	UDINT	Counter Channel_15
300.0	%I	4	UDINT	Counter Channel_16

The value of each Counter can be Reset using a specific function block inside the PLC program (see the “AT_Firmware_Lib” for details).

10-1-6 Standard & Optional Digital Outputs Status (D01... D16, OP1... OP4)

All the 16 Digital I/O channels present on the CPU can be configured as Digital Output whilst the operative mode of the 4 specific OP ones is fixed.

The commands of all of them can be managed by using 2 dedicated specific word data type, at the following addresses:

Addr..	Memory type	Size [Bytes]	Data type	Data
40.0	%Q	2	WORD	Relay/SSR drive OP commands
44.0	%Q	2	WORD	Standard DO commands

Note: The DO1... DO16 are mapped as complete commands bit mask (xx.0... xx.15) while the OP ones use only some of them (xx.0... xx.3).

10-1-7 Analogue Output Value (AO1... AO4)

The 4 analogue output channels are optional, and the possible choices are:

- no analogue outputs;
- 2 analogue outputs;
- 4 analogue outputs.

Even if the AO channels are optional, the specific memory areas are anyway reserved.

The data format chosen is REAL 32 bit floating point and, for the active channels, the user has to write the percentage value at the following addresses:

Addr..	Memory type	Size [Bytes]	Data type	Data
0.0	%Q	4	REAL	AO value Channel_1
4.0	%Q	4	REAL	AO value Channel_2
8.0	%Q	4	REAL	AO value Channel_3
12.0	%Q	4	REAL	AO value Channel_4

10-2 Battery, Retain Variables, CPU & EXP Production code Status

10-2-1 Battery and Retentive Memory Status

Addr..	Memory type	Size [bit]	Format	Data
0.0	%MX	1	BIT	Battery status (0 = Level Low, 1 = OK)
0.1	%MX	1	BIT	Classic Retain Variables Startup Status (0 = CRC error, 1 = OK)
0.2	%MX	1	BIT	Reserved
0.3	%MX	1	BIT	CPU Production Code (0 = CRC error, 1 = OK)
0.4	%MX	1	BIT	EXP1 Production Code (0 = CRC error, 1 = OK)
0.5	%MX	1	BIT	EXP2 Production Code (0 = CRC error, 1 = OK)

10-2-2 I/O Configuration Information

Digital Channels Configuration Information

Addr..	Memory Type	Size [Bytes]	Data Type	Data
20	%M	2	WORD	Digital Channels Type (0 = DO, 1 = DI)
24	%M	2	WORD	Digital Channels Mode (0 = Standard, 1 = Counter)

Analogue Configuration Information

Addr..	Memory type	Size [Bytes]	Data type	Data
40.0	%M	1	BYTE	AI Configuration Channel_1
41.0	%M	1	BYTE	AI Configuration Channel_2
42.0	%M	1	BYTE	AI Configuration Channel_3
43.0	%M	1	BYTE	AI Configuration Channel_4
...
60.0	%M	1	BYTE	AI Channel_1 E.U. (note)
61.0	%M	1	BYTE	AI Channel_2 E.U. (note)

Addr..	Memory type	Size [Bytes]	Data type	Data
61.0	%M	1	BYTE	AI Channel_3 E.U. (note)
63.0	%M	1	BYTE	AI Channel_4 E.U. (note)
...
80.0	%M	1	BYTE	Pulse Count Config. Channel_1
81.0	%M	1	BYTE	Pulse Count Config. Channel_2
...
100.0	%M	1	BYTE	AO Configuration Channel_1
101.0	%M	1	BYTE	AO Configuration Channel_2
102.0	%M	1	BYTE	AO Configuration Channel_3

Note: The value of the Analogue Input channel (in Engineering Units) can be set as:
0 = °C,
1 = K,
2 = °F.

10-2-3 CPU & Expansions Production Code Management Variables

Model Code

Addr..	Memory type	Size [Bytes]	Data type	Data
800.0	%M	1	BYTE	CPU Model Code - Character_1
...
807.0	%M	1	BYTE	CPU Model Code - Character_8

Field Code

Addr..	Memory type	Size [Bytes]	Data type	Data
808.0	%M	2	BYTE	Field Code "A" - Display
810.0	%M	2	BYTE	Field Code "B" - OP Digital Output
812.0	%M	2	BYTE	Field Code "C" - Analogue Input
814.0	%M	2	BYTE	Field Code "D" - Analogue Output
816.0	%M	3	BYTE	Field Code "E" - Digital Channels
819.0	%M	2	BYTE	Field Code "F" - Fieldbus
821.0	%M	3	BYTE	Field Code "G" - COM Ports
824.0	%M	2	BYTE	Field Code "H" - Packaging & Case

HW and SW versions

Addr..	Memory type	Size [Bytes]	Data type	Data
826.0	%M	3	BYTE	Field Code "I" - Customization & Co.
829.0	%M	5	BYTE	Field Code "J" - Preloaded Application
834.0	%M	2	BYTE	Field Code "K" - Release

Serial Number Code

Addr.	Memory type	Size [Bytes]	Data type	Data
838.0	%M	1	BYTE	Serial Number - Character 1
...
845.0	%M	1	BYTE	Serial Number - Character_8

HW and FW versions

Addr.	Memory type	Size [Bytes]	Data type	Data
846.0	%M	1	BYTE	HW code identifier - Main
847.0	%M	1	BYTE	HW code identifier - Sub
848.0	%M	1	BYTE	FW code identifier - Main
849.0	%M	1	BYTE	FW code identifier - Sub

Note: The same exact information related to the 2 possible local expansions have respectively a memory offset of 50 and 100, starting from the first memory address related to the CPU (EXP_1 starts at %M850.0 whilst EXP_2 from %M900.0)

10-3 Complete Memory Map

10-3-1 Input Memory Areas

Addr.	Memory type	Size [Bytes]	Data type	Data
0.0	%I	4	REAL	Cold Junction Temperature Value
4.0	%I	4	REAL	Internal CPU Temperature Value
...
20.0	%I	4	REAL	AI raw value Channel_1
24.0	%I	4	REAL	AI raw value Channel_2
28.0	%I	4	REAL	AI raw value Channel_3
32.0	%I	4	REAL	AI raw value Channel_4
...
80.0	%I	1	BYTE	AI Status Channel_1
81.0	%I	1	BYTE	AI Status Channel_2
82.0	%I	1	BYTE	AI Status Channel_3
83.0	%I	1	BYTE	AI Status Channel_4
...
100.0	%I	1	BYTE	AO Status Channel_1
101.0	%I	1	BYTE	AO Status Channel_2
102.0	%I	1	BYTE	AO Status Channel_3
103.0	%I	1	BYTE	AO Status Channel_4
...
110.0	%I	1	BYTE	Status Digital Channels
111.0	%I	1	BYTE	Status CNT1 Channel

Addr.	Memory type	Size [Bytes]	Data type	Data
112.0	%I	1	BYTE	Status CNT2 Channel
...
120.0	%I	1	BYTE	Expansion Unit_1 Status
121.0	%I	1	BYTE	Expansion Unit_2 Status
...
140.0	%I	4	REAL	AI value Channel_1
144.0	%I	4	REAL	AI value Channel_2
148.0	%I	4	REAL	AI value Channel_3
152.0	%I	4	REAL	AI value Channel_4
...
200.0	%I	1	REAL	Frequency value Input_1
204.0	%I	1	REAL	Frequency value Input_2
...
220.0	%I	2	UINT	CNT1 Pulse Counter
222.0	%I	2	UINT	CNT1 no. of Counter overflow
224.0	%I	2	UINT	CNT2 Pulse Counter
226.0	%I	2	UINT	CNT2 no. of Counter overflow
...
240.0	%I	4	UDINT	Counter Channel_1
244.0	%I	4	UDINT	Counter Channel_2
248.0	%I	4	UDINT	Counter Channel_3
252.0	%I	4	UDINT	Counter Channel_4
256.0	%I	4	UDINT	Counter Channel_5
260.0	%I	4	UDINT	Counter Channel_6
264.0	%I	4	UDINT	Counter Channel_7
268.0	%I	4	UDINT	Counter Channel_8
272.0	%I	4	UDINT	Counter Channel_9
276.0	%I	4	UDINT	Counter Channel_10
280.0	%I	4	UDINT	Counter Channel_11
284.0	%I	4	UDINT	Counter Channel_12
288.0	%I	4	UDINT	Counter Channel_13
292.0	%I	4	UDINT	Counter Channel_14
296.0	%I	4	UDINT	Counter Channel_15
300.0	%I	4	UDINT	Counter Channel_16
...
320.0	%I	2	WORD	Standard DI status
324.0	%I	2	WORD	Special DI status

10-3-2 Output Memory Areas

Addr.	Memory type	Size [Bytes]	Data type	Data
0.0	%Q	4	REAL	AO value Cannel_1
4.0	%Q	4	REAL	AO value Cannel_2
8.0	%Q	4	REAL	AO value Cannel_3
12.0	%Q	4	REAL	AO value Cannel_4
40.0	%Q	2	WORD	Relay/SSR drive OP commands
44.0	%Q	2	WORD	Standard DO commands

Note: The same exact information related to the 2 possible local expansions have respectively a memory offset of 400 and 800, starting from the first memory address related to the CPU (EXP_1 starts at %I400.0 whilst EXP_2 from %I800.0).

10-3-3 Marker Memory Areas

Addr.	Memory type	Size [Bytes]	Data type	Data
0.0	%MX	1	BIT	Battery status (0 = Level Low, 1 = OK)
0.1	%MX	1	BIT	Retain Variables Startup Status (0 = CRC error, 1 = OK)
0.2	%MX	1	BIT	Reserved
0.3	%MX	1	BIT	CPU Production Code (0 = CRC error, 1 = OK)
0.4	%MX	1	BIT	EXP1 Production Code (0 = CRC error, 1 = OK)
0.5	%MX	1	BIT	EXP2 Production Code (0 = CRC error, 1 = OK)
0.0	%MX	1	BIT	Battery status (0 = Level Low, 1 = OK)
...
40.0	%M	1	BYTE	AI Configuration Channel_1
41.0	%M	1	BYTE	AI Configuration Channel_2
42.0	%M	1	BYTE	AI Configuration Channel_3
43.0	%M	1	BYTE	AI Configuration Channel_4
...
60.0	%M	1	BYTE	AI Channel_1 E.U.
61.0	%M	1	BYTE	AI Channel_2 E.U.
61.0	%M	1	BYTE	AI Channel_3 E.U.
63.0	%M	1	BYTE	AI Channel_4 E.U.
...
80.0	%M	1	BYTE	Pulse Count Config. Channel_1
81.0	%M	1	BYTE	Pulse Count Config. Channel_2
...
100.0	%M	1	BYTE	AO Configuration Channel_1
101.0	%M	1	BYTE	AO Configuration Channel_2
102.0	%M	1	BYTE	AO Configuration Channel_3

103.0	%M	1	BYTE	AO Configuration Channel_4
...
800.0	%M	1	BYTE	CPU Model Code - Character_1
801.0	%M	1	BYTE	CPU Model Code - Character_2
802.0	%M	1	BYTE	CPU Model Code - Character_3
803.0	%M	1	BYTE	CPU Model Code - Character_4
804.0	%M	1	BYTE	CPU Model Code - Character_5
805.0	%M	1	BYTE	CPU Model Code - Character_6
806.0	%M	1	BYTE	CPU Model Code - Character_7
807.0	%M	1	BYTE	CPU Model Code - Character_8
808.0	%M	2	BYTE	Field Code "A" - Display
810.0	%M	2	BYTE	Field Code "B" - OP Digital Output
812.0	%M	2	BYTE	Field Code "C" - Analogue Input
814.0	%M	2	BYTE	Field Code "D" - Analogue Output
816.0	%M	3	BYTE	Field Code "E" - Digital Channels
819.0	%M	2	BYTE	Field Code "F" - Fieldbus
821.0	%M	3	BYTE	Field Code "G" - COM Ports
824.0	%M	2	BYTE	Field Code "H" - Packaging & Case
826.0	%M	3	BYTE	Field Code "I" - Customization & Co.
829.0	%M	5	BYTE	Field Code "J" - Preloaded Application
834.0	%M	2	BYTE	Field Code "K" - Release
836.0	%M	2	BYTE	RESERVED
838.0	%M	1	BYTE	Serial Number - Character 1
839.0	%M	1	BYTE	Serial Number - Character 2
840.0	%M	1	BYTE	Serial Number - Character 3
841.0	%M	1	BYTE	Serial Number - Character 4
842.0	%M	1	BYTE	Serial Number - Character 5
843.0	%M	1	BYTE	Serial Number - Character 6
844.0	%M	1	BYTE	Serial Number - Character 7
845.0	%M	1	BYTE	Serial Number - Character_8
846.0	%M	1	BYTE	HW code identifier - Main
847.0	%M	1	BYTE	HW code identifier - Sub
848.0	%M	1	BYTE	FW code identifier - Main
849.0	%M	1	BYTE	FW code identifier - Sub

Chapter 11

Ascon Technologic Function Blocks Libraries

In this chapter are listed and described the libraries part of AT Automation Suite and those FBs which are available only from the CPU device firmware. For every library, we have prepared a complete list of function blocks with a brief description of each one. In case of need, more details are available from the specific documentation.

11-1 AT_Generic_Advanced_Lib

The *AT_Generic_Advanced_Lib* is the library which contains the set of very generic functionalities, in part inherited from the old AC-Station series, useful for generic purposes (see the “*IEC 61131-3 Function Block Library*” [4] manual for details). The table hereafter reported gives the specific list of FBs part of the library.

Function Block name	Description
AVG_ADV_8REAL	Advanced Instantaneous Average calculation
AVG_MOVING	Moving Average calculation
AVG_RUNNING	Running Average calculation
CHAR_08_ARRAY	Analogue Conversion using an 8 points array input
CHAR_16_ARRAY	Analogue Conversion using a 16 points array input
CHARACTERIZER_8	Linear Interpolation with 8 points
CHARACTERIZER_16	Linear Interpolation with 16 points
COMPARATOR	Comparator with hysteresis Function Block
CONV_AD8	From BYTE to 8 bits
CONV_AD16	From WORD to 8 bits
CONV_AD32	From DWORD to 8 bits
CONV_DA8	From bits to BYTE
CONV_DA16	From bits to WORD
CONV_DA32	From bits to DWORD
COUNTER	Rising Edge Counter
DECODER_8	Decoder Function Block
FLIPFLOP_D	D Type FlipFlop Function Block
FLIPFLOP_JK	JK Type FlipFlop Function Block
HOLD_VALUE	Sample & Hold Function Block
INBETWEEN	Middle Selector Function Block
LIMITER_VALUE	Limiter Function Block

Function Block name	Description
MIN_MAX_SELECTOR	Min/Max Selector Function Block
MONOSTABLE_DS	Monostable with Delay
MONOSTABLE_NED	Monostable with Delay on the Negative Edge
MONOSTABLE_PED	Monostable with Delay on the Positive Edge
MONOSTABLE_PUL	Monostable Pulse Generator
MS_MANAGER	USB Mass Storage operations manager
MUX_A8	Analog Multiplexer 8 Input
MUX_A16	Analog Multiplexer 16 Input
MUX_D8	Digital Multiplexer 8 Input
MUX_D16	Digital Multiplexer 16 Input
SAMPLING_TIME	Calculation of Actual, Min and Max CPU cycling time
RESCALE	Rescaling Function Block
POWER_FAIL	Power Fail Condition Monitor
SLOPE_LIMIT	Slope Limiter
TIMER_ADV	Advanced countdown timer function block
TOTALIZER	Totalizer Function Block
TOTALIZER_AVD	Advanced Totalizer Function Block

11-2 AT_Process_Generic_Lib

The *AT_Process_Generic_Lib* is the library which contains the set of generic process FBs.

The table hereafter reported gives the specific list of FBs part of the library..

Function Block name	Description
AI_COND_ADV	Advanced conditioning of an AI value
AI_COND_STD	Standard conditioning of an AI value
ALARM_ABS	Absolute Alarm Function Block
ALARM_ADVANCED	General Alarm Function Block
ALARM_BND	Band Alarm Function Block
ALARM_DEV	Deviation Alarm Function Block
ALARM_RATE	Rate Alarm Function Block
DEW_POINT	Dew Point calculation
F0_CALCULATION	Sterilization time for bacterial load reduction calculation
HR_DRY_WET_BULB	Relative humidity calculation method with dry/wet bulb
MASS_FLOW	Compensate Flow calculation
ZrO2_PROBE	% Carbon Potential calculation
ZrO2_PROBE_CLN	% Carbon potential probe cleaning management

11-3 AT_Process_Control_Lib

The *AT_Process_Control_Lib* is a function block library dedicated to process control and includes advanced function blocks combining basic PID functions coming within the nP4 Firmware, in order to provide a very easy and ready to use solution.

The most advanced function blocks in the library is a complete standard single action PID controller and the equivalent double action, for heat and cool applications.

Advanced auto-tuning function blocks are also included within the library, using different tuning algorithms such as “*Natural Frequency*” or “*Step Response*”.

The table hereafter reported gives the specific list of FBs part of the library (see the “*IEC 61131-3 Function Block Library*” [4] manual for details).

Function Block name	Description
S2_CONTROLLER_ADV	Advanced Single Action Controller
S2_CONTROLLER	Single Action Controller
S2_EZ_TUNE	Tuning with Modified Step Response Algorithm for Single Action Loops
S2_FILTER	First Order Filter
S2_HC_CONTROLLER_ADV	Advanced Double Action Controller (Heat and Cool)
S2_HC_CONTROLLER	Double Action Controller (Heat and Cool)
S2_HC_EZ_TUNE	Tuning with Modified Step Response Algorithm for Heat and Cool Loops
S2_HC_TFUZZY	Tuning with Fuzzy Logic for Heat and Cool Loops
S2_HC_TNATFREQ	Tuning with Natural Frequency Algorithm for Heat and Cool Loops
S2_HC_TSTEPRESP	Tuning with Step Response Algorithm for Heat and Cool Loops
S2_HCMV	Auto/Man station for output manual value direct access for double action loop
S2_MV	Auto/Man station for output manual value direct access for single action loop
S2_SPLITMV	Auto/Man station for output manual value direct access for double action loop with Split Range
S2_TFUZZY	Tuning with Fuzzy Logic for Single Action Loops
S2_TNATFREQ	Tuning with Natural Frequency Algorithm for Single Action Loops
S2_TSTEPRESP	Tuning with Step Response Algorithm for Single Action Loops

11-4 AT_Communications_Lib

The *AT_Communications_Lib* allows a simplified access to the communication functions of Ascon Technologic CPUs (see the “*IEC 61131-3 Function Block Library*” [4] manual for details).

The table hereafter reported gives the specific list of FBs part of the library.

Function Block name	Description
COMMS_MNGT_CU02	CU02 Serial Comm Ports Management
COMMS_MNGT_CU02_PB	CU02 Profibus Serial Comm Ports Management
COMMS_MNGT_M81	M81 Serial Comm Ports Management
COMMS_MNGT_MP0x	microPAC MP0x Serial Comm Ports Management
COMMS_MNGT_nP4	nP4 Serial Comm Ports Management

Function Block name	Description
MB_MST_SYNC	Modbus Master: Synchronization of operations
MB_MST_RD_COIL	Modbus Master: Coil reading
MB_MST_WR_COIL	Modbus Master: Coil writing
MB_MST_RD_WORD	Modbus Master: Word reading
MB_MST_WR_WORD	Modbus Master: Word writing
MB_16WORD_TO_ARRAY	Modbus Master: packaging of 16 WORD in an array
MB_ARRAY_TO_16WORD	Modbus Master: un-packaging of an array into 16 WORD
MB_MST_RD8_DINT	Modbus Master: management of 8 DINT read values
MB_MST_RD8_DWORD	Modbus Master: management of 8 DWORD read values
MB_MST_RD8_REAL	Modbus Master: management of 8 REAL read values
MB_MST_RD8_UDINT	Modbus Master: management of 8 UDINT read values
MB_MST_WR8_DINT	Modbus Master: management of 8 DINT write values
MB_MST_WR8_DWORD	Modbus Master: management of 8 DWORD write values
MB_MST_WR8_REAL	Modbus Master: management of 8 REAL write values
MB_MST_WR8_UDINT	Modbus Master: management of 8 UDINT write values
MB_SLV_RD8_DWORD	Modbus Slave: reading of 8 DWORD values
MB_SLV_RD8_REAL	Modbus Slave: reading of 8 REAL values
MB_SLV_RD16_WORD	Modbus Slave: reading of 16 WORD values
MB_SLV_RD32_DIGITAL	Modbus Slave: reading of 32 digital values
MB_SLV_RD_DIGITAL	Modbus Slave: reading a digital value
MB_SLV_RD_DWORD	Modbus Slave: reading a DWORD value
MB_SLV_RD_REAL	Modbus Slave: reading a REAL value
MB_SLV_RD_WORD	Modbus Slave: reading a WORD value
MB_SLV_WR8_DWORD	Modbus Slave: writing of 8 DWORD values
MB_SLV_WR8_REAL	Modbus Slave: writing of 8 REAL values
MB_SLV_WR16_WORD	Modbus Slave: writing of 16 WORD values
MB_SLV_WR32_DIGITAL	Modbus Slave: writing of 32 digital values
MB_SLV_WR_DIGITAL	Modbus Slave: writing a digital value
MB_SLV_WR_DWORD	Modbus Slave: writing a DWORD value
MB_SLV_WR_REAL	Modbus Slave: writing a REAL value
MB_SLV_WR_WORD	Modbus Slave: writing a WORD value
MODEM_CHECK	Modem operational verification
MODEM_CONF	Modem configuration management
MODEM_SMS_SEND	Modem SMS (Short text Message Service) send management
SEND_EMAIL	SMTP server Configuration
SERIAL_PORTS	Set the configuration for the Modbus RTU ports of the CU unit
SYS_OPRS_MNGT	Set communication operational parameters on Modbus RTU and TCP agents
TCP_IP_PORT	Set the configuration for the Modbus TCP port

11-5 AT_Firmware_FBs List

The *AT_Firmware_FBs_Lib* coming within each Ascon Technologic CPU is listed in this section.

Keep in mind that, over the past 20 years, Ascon Technologic has evolved, improved and fixed his own firmware: for this reason, the list of FBs which follows refers to the very last version of the firmware released within the **nP4** hardware platform but can be different when referred to the past ones available on the old CPUs.

For each of the FBs is provided a short description (see the “*AT_Firmware_FBs_Lib*” [3] manual for details): for more details please refer to the specific help documentation available in the OpenPCS programming tool.

Function Block name	Description
ASCON_FLATTEN_TO_REAL	Convert the 4 bytes of the input parameters as the flattened equivalent of a real number which is then output-returned
ASCON_REAL_TO_FLATTEN	Convert the REAL variables in their FLATTEN equivalents
CLOSE_MODBUS_TCP_SERVER	Disable MBTCP/IP Server
CLOSE_SERIAL_COMM	Close the serial communication port
CONV_ASCII_TO_CHAR	ASCII conversion from binary code to character
CONV_CHAR_TO_ASCII	ASCII conversion from character to binary code
CTD	Counter Down pulses
CTRL_HCMV	Automan Station for heat and cool regulation
CTRL_MV	Automan Station for single action regulation
CTRL_PID	PID algorithm
CTRL_SPLITMV	Automan Station for heat and cool regulation with split range
CTRL_SRV	Servomotors algorithm
CTRL_SRV_POS	Servomotors algorithm close loop (potentiometer)
CTRL_TPO	Time proportional output
CTU	Counter Up pulses
CTUD	Counter Up/Down pulses
DINT_TO_TIME	Conversion between specific Data Type
ENABLE_MODBUS_TCP_SERVER	Set and activate the MBTCP/IP Server agent
F_TRIG	Falling edge detection
R_TRIG	Rising edge detection
MB_TCP_CLOSE_CONN	Close one of the 10 active connections
MB_TCP_CONN_STATUS	Show the status of a MBTCP/IP connection
MB_TCP_GET_CONN_BY_ADDR	Return information of a connection identified by the IP address of the client
MB_TCP_GET_CONN_CONFIG	Return configuration data of a specified active connection
MEMCOPYY_FROM_M	Copies data from %M memory areas
MEMCOPYY_TO_M	Copies data into %M memory areas
MEMCPY_I_TO_M	Copy a specific %I memory into a specific %M memory area
MEMCPY_M_TO_M	Copy a specific %M memory into a specific %M memory area
MEMCPY_M_TO_Q	Copy a specific %M memory into a specific %Q memory area
MEMCPY_Q_TO_M	Copy a specific %Q memory into a specific %M memory area

Function Block name	Description
MODBUS_GET_DIGITAL_SLAVE	Read 16 digital value from a memory area dedicated to a MB slave
MODBUS_GET_SLAVE_DATA	Read registers from a memory area dedicated to a MB slave
MODBUS_MASTER_EXECUTE	Execute a query in compliance with the MB protocol
MODBUS_MASTER_STATUS	Check the status of the MB agent.
MODBUS_SET_DIGITAL_SLAVE	Write 16 digital value to a memory area dedicated to a MB slave
MODBUS_SET_DWORD_DATA	Write two contiguous registers (4 bytes) to a memory area dedicated to a MB slave
MODBUS_SET_WORD_DATA	Write registers to a memory area dedicated to a MB slave
MODBUS_SLAVE_SETTINGS	Set the node_id and timeout parameters of the MB slave agent
MODBUS_SLAVE_STATUS	Check the status of the MB agent
MS_DATALOG_MNGT	Mass Storage datalogging management
MS_INFO	Mass Storage information
OPEN_SERIAL_COMM	Configure the serial port and set the protocol used on it
RAND	Generete random numbers from 0... 65535
RESET_PULSE_COUNTER	Reset the counter value connected to a specific digital input
RTC_SETUP	Set the system clock
RTC_GET_VALUES	Read the system clock
RS	Reset dominant Flip-Flop
RTC_GET_VALUES	Read the system clock
RTC_SETUP	Set the system clock
SEND_EMAIL	Set the configuration for a client SMTP to send e-mail
SERIAL_IO_CONFIG	Configure the ASCII serial port
SERIAL_IO_READ	Read data from the ASCII serial port
SERIAL_IO_READ_BYTE	ASCII serial port Byte reading
SERIAL_IO_WRITE	Write data on the ASCII serial port
SERIAL_IO_WRITE_BYTE	ASCII serial port Byte writing
SR	Set dominant Flip-Flop
TIME_TO_DINT	Conversion between specific Data Type
TIME_TO_LREAL	Conversion between specific Data Type
TIME_TO_REAL	Conversion between specific Data Type
TOF	Delay OFF timer
TON	Delay ON timer
TP	Time pulse generator
WATCHDOG_SET	Configure the system watchdog
WATCHDOG_STATUS	Checking the status of the system watchdog

Appendix A

The Bootloader in the PAC project



WARNING

In order to protect the data and files present in the system, prior to perform a Firmware update, it is necessary to make a backup of them. Further details about this operation can be found at “*USB Mass Storage Device*” on page 39.

A-1 How to update the CPU Firmware

Inside the CPU runs a program, named `Bootloader`, which manages all the activities related to the Firmware update.

The Firmware update process is characterized by 2 different procedures involving some specific files, via the USB (local) or the Ethernet (remote) port.

While the system is normally running, the Bootloader can be activated to get a new Firmware, waits until it recognize it and then reboots.

A-2 Bootloader Startup

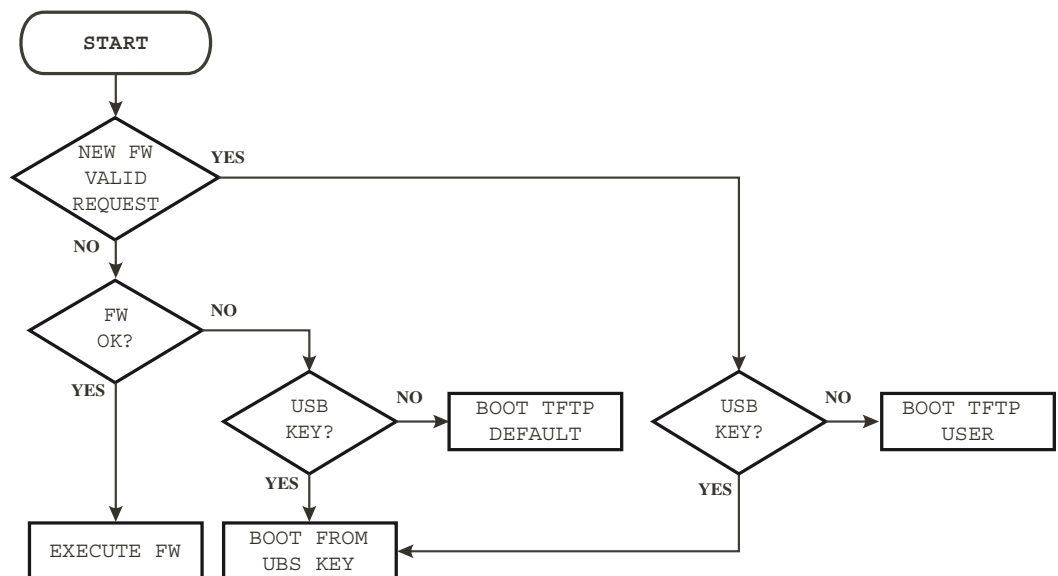

A-3 Remote Firmware Update

The remote Firmware update operation needs a TFTP function over the Ethernet port. While the instrument is normally running, the steps to follow are:

1. Start a TFTP client to connect with the CPU (the connection parameters are IP address 192.168.5.11 port 69);
2. Send to the CPU the `/FS2/BOOTGO.TXT` file which contains the Digital Signature related to the Firmware file to be downloaded: the CPU will automatically reboot in “detect mode”, awaiting for a new file;
3. Make a backup of the actual CPU Firmware uploading the file `/FS2/FWUP.HEX` from the CPU;
4. Start to download the `/FS2/FWDOWN.HEX` Firmware file: the process can take up to several minutes;
5. When the Download process has ended, the CPU verifies the quality and the signature of the received Firmware file and then proceeds to update the Flash memory. This phase requires some tens of seconds;
6. Finally Download the file `/FS2/RMTCMD.TXT` that contains the text “reset” which causes the reboot of the CPU with the new Firmware.

All over the Firmware update operations it is possible to know the status by periodically getting the file `/FS2/ACTSTAT.TXT` which is continuously updated with the code explaining the specific status (see the tables that follow).



WARNING

In case of any error during the TFTP upgrade operations, the CPU holds pointing out the error condition with a triple flash of the RUN (green) and/or the solid ON status of the MSG (red) LEDs. To abort the procedure it is necessary to download the file `/FS2/RMTCMD.TXT` that containing the text “kill”: the CPU will reboot automatically, following the “*Bootloader Startup*” on page 73 flow chart.

A-4 Local Firmware Update

Locally, the Firmware update is carried out using an USB memory key.

While the instrument is normally running, the steps to follow are:

1. Format a USB key in FAT32 mode.
2. Create a directory named `FWUPGR` and copy into it the files `BOOTGO.TXT` and `FWDOWN.HEX`;
3. At Power ON, if the Firmware detects a USB key inserted in the specific port, it waits 3 seconds for the operator to press the **PB** button;
4. The CPU copies the actual internal Firmware files (`FWUP.HEX` and `BOOTVER.TXT`) on the USB key into the folder `FWUPGR`.
5. At this point the CPU verifies the signature of the `FWDOWN.HEX` Firmware file and, if it is correct, gets it from the USB key. The process can take a few minutes;
6. When the process has ended the CPU proceeds to update the Flash memory.
7. A double flash of the RUN LED (green) indicates to remove the USB key in order to reboot the system with the new Firmware.

All the above described phases are highlighted by specific LEDs indications.

**WARNING**

In case of any error during the USB upgrade operations, the CPU holds pointing out the error condition with a triple flash of the RUN (green) and/or the solid ON status of the MSG (red) LEDs. When this happens, the file **ACTSTAT.TXT** will be anyway created. Restart the procedure from point 2.

A-5 Update Firmware reference Tables

During the Firmware update procedure it is possible to ask to the system the status of the procedure itself. This information is loaded in the file:

ACTSTAT.TXT which is continuously updated.

The information are:

Status (xx)(yy)

Where

Status: **WIP** (Work in Progress) The system is running the update procedure;
OK The update procedure has ended with no errors;
KO The update procedure has ended with errors.

xx Is the phase of the update procedure in execution.

yy Is the error detected during the update procedure.

Phases of the update procedure (**xx** codes):

Code	Phase	Description
0	BOOT_INI_STATUS	Initialize Boot
1	BOOT_CHECK_MEDIUM_STATUS	Determines which kind of media has to be used
2	BOOT_CHECK_JUMP_STATUS	Check if jump to a valid application or not
3	BOOT_INIT_BACKEND_STATUS	Initialize backend medium
4	BOOT_WAIT_FW_BACKEND_STATUS	Wait a firmware using the underlying technology
5	BOOT_COMPARE_SIGNATURES_STATUS	Compare file signature with backup RAM signature
6	BOOT_CHECK_SIGNATURE_STATUS	Check firmware signature
7	BOOT_CHECK_UPLOAD_STATUS	Check whether the upload is needed or not
8	BOOT_COPY_FIRMWARE_STATUS	Copy firmware to external memory, converting it in HEX format
9	BOOT_FWUP_BACKEND_STATUS	Firmware upload using the underlying technology
10	BOOT_ERASE_FLASH_STATUS	Erase Flash
11	BOOT_PROGRAM_FW_STATUS	Erase and program flash
12	BOOT_STORE_REGIONS_STATUS	Store firmware regions information
13	BOOT_WRITE_KEY_STATUS	Write Key to validate the just programmed firmware
14	BOOT_JUMP_STATUS	Jump to the application
15	BOOT_ERR_STATUS	Error Status
16	BOOT_END_STATUS	End Status

Error detected during the update procedure (YY codes):

Code	Phase	Description
0	BOOT_ERR_OK	No error
1	BOOT_ERR_MSC_HOST_MOUNT	Something gone wrong while mounting the volume
2	BOOT_ERR_MSC_HOST_INIT	Something gone wrong while initializing MSC HOST
3	BOOT_ERR_MSC_HOST_FOPEN	Something gone wrong while opening file (msc host)
4	BOOT_ERR_MSC_HOST_FREAD	Something gone wrong while reading file (msc host)
5	BOOT_ERR_MSC_HOST_FCLOSE	Something gone wrong while closing file (msc host)
6	BOOT_ERR_MSC_HOST_DISCONNECTED	USB Stick disconnected too early (msc host)
7	BOOT_ERR_MSC_HOST_GETVER	Something gone wrong while getting bootloader version (msc host)
8	BOOT_ERR_DIFFERENT_SIGNATURES	File signature and backup RAM signature are different
9	BOOT_ERR_SIGNATURE_NOT_VALID	Signature is not valid
10	BOOT_ERR_ERASE_FLASH	Error occurred erasing flash
11	BOOT_ERR_FWPRG	Error occurred while programming firmware (CRC, access to flash, invalid HEX file syntax, etc.)
12	BOOT_ERR_STORE_REGIONS	Error occurred while storing firmware region information
13	BOOT_ERR_WRITEKEY	Error occurred while writing the validation key
14	BOOT_ERR_UPLOAD_COPY	Error occurred while copying firmware to external RAM for uploading
15	BOOT_ERR_MSC_HOST_UPLOAD	Error occurred while copying firmware on USB stick
16	BOOT_ERR_MSC_DEVICE_UPLOAD	Error occurred while copying firmware on RAMDISK in order to make it available through USB DEVICE MSC
17	BOOT_ERR_MSC_DEVICE_MOUNT	Something gone wrong while mounting the volume (msc device)
18	BOOT_ERR_MSC_DEVICE_FOPEN	Something gone wrong while opening file (msc device)
19	BOOT_ERR_MSC_DEVICE_FREAD	Something gone wrong while reading file (msc device)
20	BOOT_ERR_MSC_DEVICE_FCLOSE	Something gone wrong while closing file (msc device)
21	BOOT_ERR_MSC_DEVICE_GETVER	Something gone wrong while getting bootloader version (msc host)
22	BOOT_ERR_PROGRAM_FW	Error while programming firmware
23	BOOT_ERR_ERROR	Error while handling error
24	BOOT_ERR_END	Error while ending operations

Appendix B

AT SigmaPAC Wizard Tool

The SigmaPAC Wizard Tool is an application especially designed to perform the offline hardware configuration of any Ascon Tecnologic's programmable CPUs. Through the same application it is possible to perform some remote commands, manage the diagnostic error tag list, the upload/download of the projects, configuration and/or retentive variables files.





B-1 User Interface

Main screen Once the software has been run, the following main screen is displayed.







Program Commands The commands to control the program are grouped in the higher part of the page. They are grouped in drop down menus, but are also displayed in graphical icon form.

File menu

Menu entry	Icon	Description
New project		Allows to create a new Configuration project
Open		Allow to open an already saved project (note)
Save		Allow to save the current project (note)
Save as		Allow to save the actual project with a desired name (note)
Exit		Exits the AT Wizard

Note: The Configuration file is saved in a proprietary format:
***.swp** = sigmaPAC Wizard Project.



Configuration

Menu entry	Icon	Description
Import Bin (1)		Allow to select/import an already saved CPU binary format Configuration file
Export Bin (1)		Allow to save the current CPU Configuration file in the binary format
Upload Configuration from device		Loads the Configuration from the CPU connected to the PC (requires the IP address)
Download Configuration from device (2)		Transfers the actual Project to a connected CPU (requires the IP address)

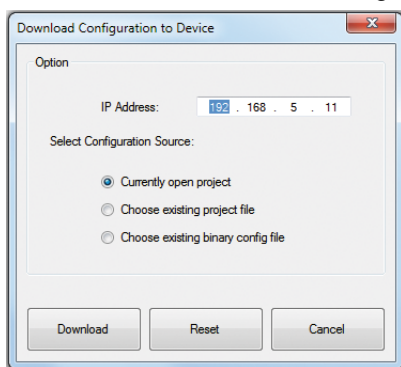
- Notes:**
1. The Configuration files in binary format (*.bin) are typically used to load the Configuration data into a CPU from a memory stick. The binary format is compatible with all the Ascon Tecnologic CPUs.
 2. The file selection is made through a specific page.



Device manager

Menu entry	Icon	Description
Device Commands (1)		Shows a panel from where the user can Start or Stop the CPU, Acknowledge the alarms, Erase the program file or Reset the CPU (Power cycle)
PLC Program - Retentive Vars (2)		Shows a popup that allows to manage (upload or download) the program and the retentive data present in the CPU

Notes: 1.



If needed, the selection of the “*Erase PLC program*” command will delete the PLC program from the media selected location: the overall time needed to perform the operation depends by the project size. Please wait until the “*Persistency setup menu*” screen reappears as confirmation for complete PLC program erasing.

2.

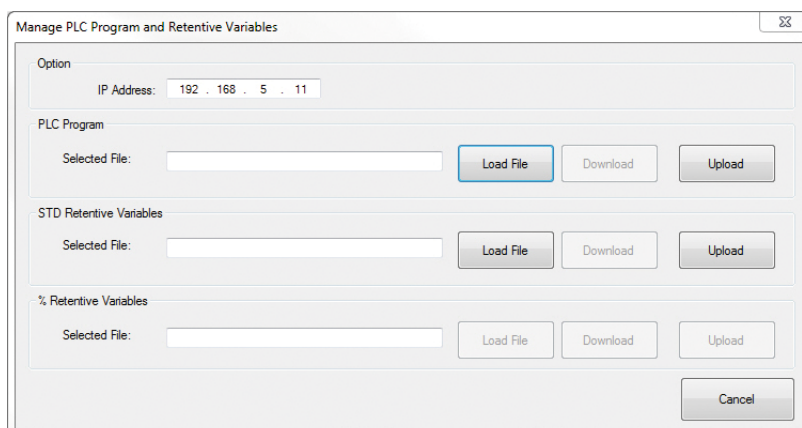

Utility

Menu entry	Icon	Description
TCP Ping Utility	...	Shows a popup (1) from where can be verified the CPU connection through the Ping utility
Upload Error Log	✖	Shows a popup (2) which allows to upload the Error Log information from the connected CPU
Run External Tool (3)	🔧	Runs a utility which allows to configure the xP4 expansion modules

Notes: 1.

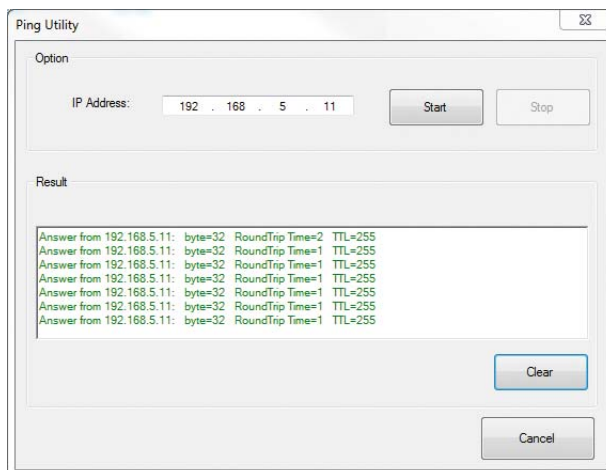

2.

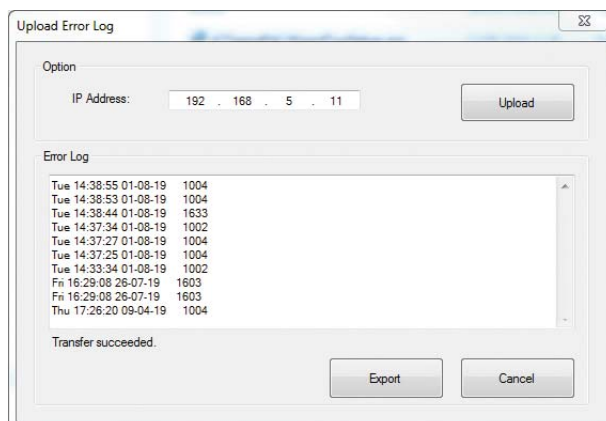

3.

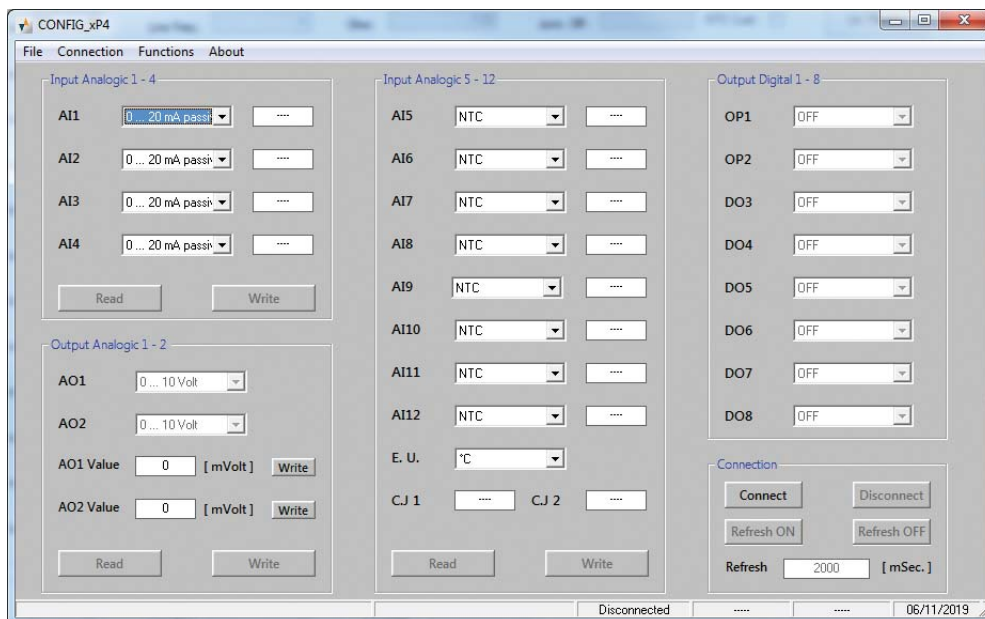

B-2 How to perform the CPU Setup

To be able to establish the connection with the CPU, it is necessary to:

- Correctly install the AT Wizard Tool on a PC specifying that the usage is for “Everyone” (in order to obtain the Administrator’s privileges);
- Know the IP address of the CPU to connect with;
- Properly connect and configure your PC in the same Ethernet subnet (Factory default CPU IP address: 192.168.5.xxx);
- Have PC full Administrator privileges;
- Allow the application to run through the Windows Firewall.

B-2-1 Create a new Configuration project

On the main screen, click on the “New project” Icon (📁) to open the “**Create New project**” page.

*New
Configuration
project screen*

The screenshot shows the 'Create New Project' dialog box. The 'Hardware Module' is set to 'ASCONECNOLOGIC nanoPAC 6.0.1.0'. The 'Order Code' section has the following configuration:

Order Code	Configuration
NP4	-- Not Provided
M	M - 2 OP relay + 2 OP SSR drive
5	5 - 4 In AI1...AI4 Universal Analogue Input & Ratiometric
4	4 - AO1...AO4 Analogue Output (2+2) isolated
88	88 - DI1...DI8 + DO1...DO8 + 2 Pulse Count
E	E - Ethernet Port 10/100
2S	2S - RS232/485 + RS485 isolated

The 'Selected Module' section shows a 3D model of the nanoPAC device. The 'Read Model from Device' section shows the IP Address: 192 . 168 . 5 . 11. There is a 'Check Model' button. At the bottom, there are 'OK' and 'Cancel' buttons.

The new configuration screen is a very important page, as helps the user in determining the Hardware configuration of the CPU.

It can be used online or offline (in the case the CPU is momentarily not connected to the PC).

Online configuration

This is the easiest way to configure the software, as the CPU is connected to the PC and powered ON, click on the “**Check Model**” button. The Wizard asks to the CPU the order code info and reports them on the screen.

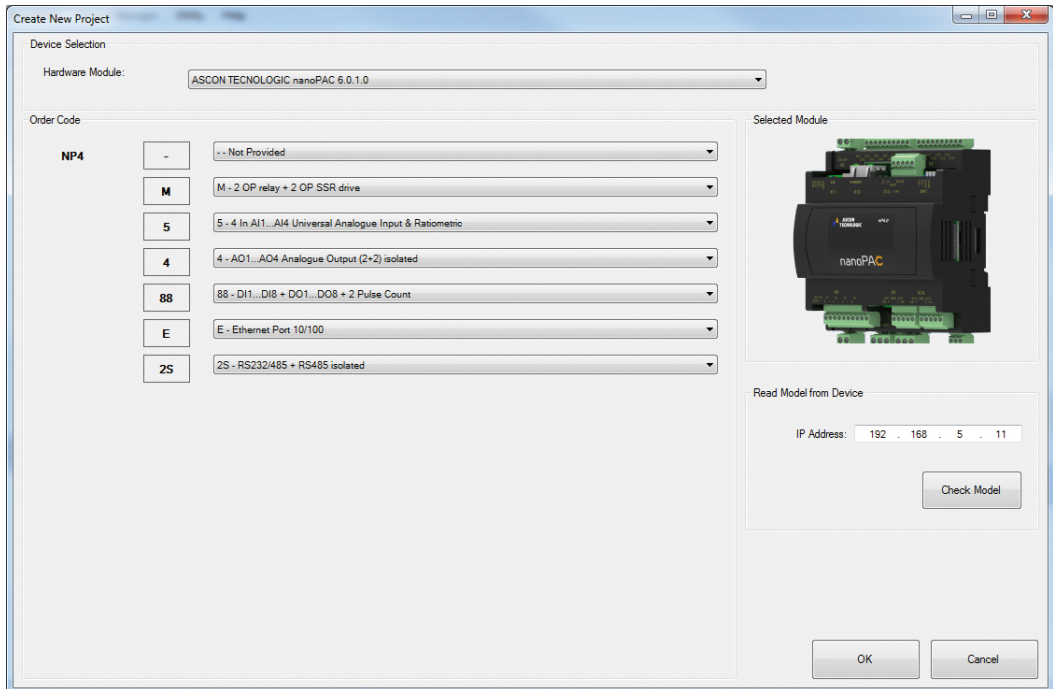

Click on the OK button, the Wizard is ready to operate.

Offline configuration

When a CPU is not connected to the PC, the configuration is a little more complex.

- First of all, the user must retrieve the CPU order code available from the backside plastic box label;
- From the scroll down menu “**Device selection**” > “**Hardware Module**”, select the correct CPU model (Ascon Tecnologic NanoPAC X.X.X.X);
- Once the software has recognized the choice, complete the mask by selecting the specific codes to populate the order code form;
- Completed the list, click on the OK button to end the Wizard configuration session.

After the new configuration project has been created and completed, is time to setup the various options available within the CPU. This can be done from the menus displayed, after the CPU has been correctly recognized.

B-3 Network Setup

This page allows to configure the communication ports parameters.

B-3-1 Ethernet Setup Menu

Item	Description	Range	Factory Default
IP Address	CPU IP Address	0.0.0.0/ 255.255.255.255	192.168.5.11
Subnet Mask	CPU subnet mask	0.0.0.0/ 255.255.255.255	255.255.255.0
Gateway Address	Network Gateway Address	0.0.0.0/ 255.255.255.255	192.168.5.10
DNS Server Address	DNS Server Address	0.0.0.0/ 255.255.255.255	192.168.5.10
Port	OpenPCS Port	0... 65535	1200
DHCP	DHCP Protocol Status	Disable/Enable	Disabled

B-3-2 Serial Setup Menu

Item	Description	Range	Factory Default
Type	COM1 type	0/1 [RS485/RS232]	RS485
Baudrate	COM1 baudrate	0... 6 [2400... 57600]	9600
Parity	COM1 parity	0... 2 [None/Even/Odd]	None
Stop bit	COM1 stop bit	1/2	1

Note: The COM2 port can be configured from the OpenPCS ambient **ONLY**.

B-3-3 CanOpen Menu

The CanOpen port is **not present** on the nP4 CPU. All the field are greyed because **not active**.

B-4 CPU Setup

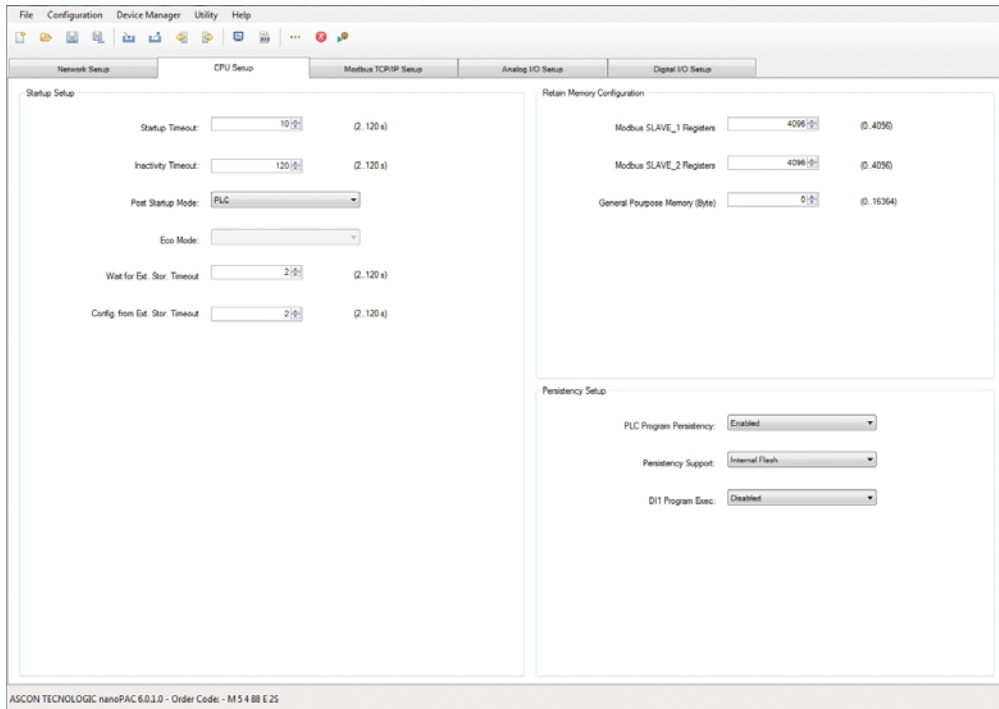

B-4-1 Startup Setup Menu

Item	Description	Range	Factory Default
Startup Timeout	Timeframe window to enter the startup session	2... 120 (s)	10
Inactivity Timeout	Inactivity Timeout (please see 3-1-3 for details)	2... 120 (s)	120
Post Startup Run	Operation phase to be executed after the startup session	PLC/I/O Watch	PLC
DO used for watchdog	Enabling DO16 for watchdog management	Disabled/Enabled	Disabled

B-4-2 Persistency Setup Menu

Item	Description	Range	Factory Default
Erase PLC Program	Command to erase the PLC program from flash memory	-	-
PLC Program Persistency	Function to save PLC program into flash memory	Disabled/Enabled	Enabled
Persistency Support	Media where to save copy of the PLC program	Internal Flash/USB key	Internal Flash
DI Control Program Exec	Reserves D01 for PLC program RUN/STOP function	Disabled/Enabled	Disabled

The CPU can save the PLC program into different persistent memory supports. Each time a program download is executed, the CPU makes a permanent copy of it into the configured desired media for the next future executions.

B-4-3 Retain Config

Item	Description	Range	Factory Default	Time to retain
MB Slave 1 Split register	Amount of Slave 1 Modbus agent retained registers	0... 4096	4096	10 ms
MB Slave 2 Split register	Amount of Slave 2 Modbus agent retained registers	0... 4096	4096	10 ms
Simple Split byte	Amount of generic memory retained bytes	0... 16384	0	15 ms

Standard and Retentive memory management

The IEC 1131 programming tool allows to declare retentive variables using specific files and syntax. These variables are handled by a 32 kB size of "non volatile memory" (for security reasons, the memory is duplicated for redundancy and refreshed during runtime operations). Differently, it is possible to declare variables up to 32 kB in the % marker memory area (8192 Bytes for each Modbus slave agent).

In particular, the range available as retentive is:

Modbus Slave 1: %MW1128.0... %MW9320.0 (8192)

Modbus Slave 2: %MW10128.0... %MW18320.0 (8192)

Marker Area: %MB22000.0... %MB38384.0 (16384)

From the CPU setup session, by dedicated entries, it is possible to define the amount of registers/Bytes to be retained.

Note: The process which saves the retentive variables operates in parallel with the PLC application: for this reason the cycle time of the whole project will be effected/delayed ONLY!

- In case of **"Cold start"** command, the standard retentive variables will be reset or preset to the initialization value whereas the % retentive variables will be reset. In case of retain file corruption error, both the two memory areas are separately reset or initialized.
- In case of **"Warm Start"** command, if the PLC program has not been modified, both the standard and % retentive variables will remain to last previous values. In case of retain file corruption, the % retentive variables will be reset.
- In case of **"Hot start"** command, both the standard and % retentive variables will be unaffected.

It is possible to upload/download the whole retentive memory areas, standard and % variables (using a TFTP session). It is possible to perform this operation ONLY in the timeframe window available during the CPU boot-up phase, before the Device Configuration timeframe session. On how to perform the upload or download the specific retentive memory files, please refer to the:

"Device command" (page 159) or "*sigmaline nanoPAC nP4.0 User Manual*" at paragraph: "*Chapter 9 - CPU Configuration Software (TFTP File Access)*".

The CPUs User Manuals can be freely downloaded from the Ascon Tecnologic Internet site.

B-5 Modbus TCP/IP Setup

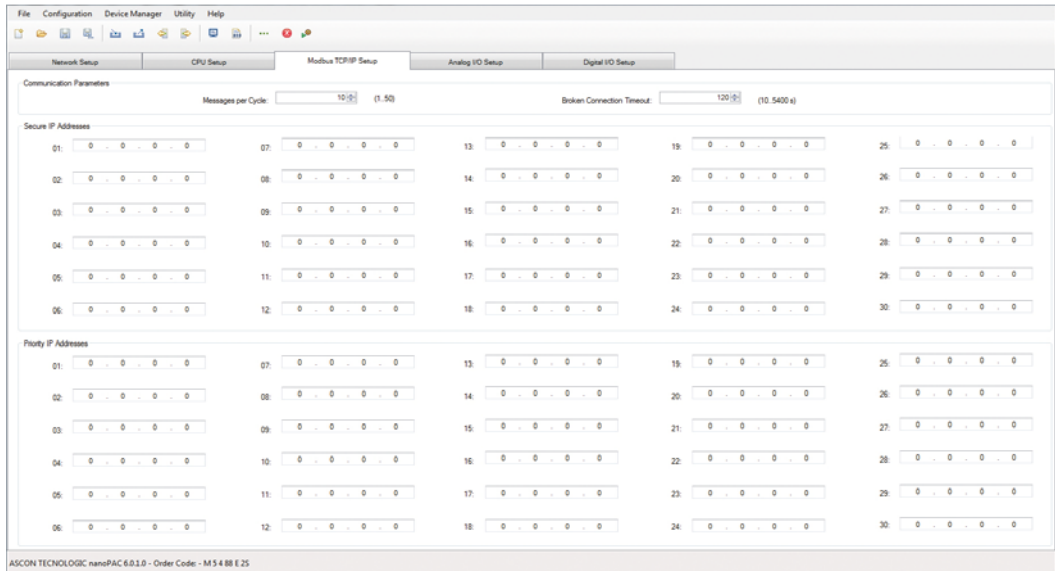

Item	Description	Range	Factory Default
Messages per Cycle	Max. number of processed messages per cycle	1... 50	10
Broken Connection Timeout	Inactivity Timeout of a TCP/IP connection	10... 5400 (s)	120
Secure Address Setup	Secure IP Address Setup Menu	-	-
Priority Address Setup	Priority IP Address Setup Menu	-	-

To verify the connection status after a long period of inactivity, is used the TCP/IP “keep alive” protocol. The protocol performs the following sequential steps:

1. At each received message the timeout is reset;
2. If timeout expires, a “test” message is sent in order to verify if the connection is still active;
3. If an answer to the “test” is received, then the timeout is reset;
4. In case of no answer, the “test” will be sent again three times, every 10 s;
5. If even after the fourth “test” nothing has been received, the connection will be closed.

B-5-1 Modbus TC/IP Secure Addresses Table Menu

If the security function will be enabled (please see the “AT_Firmware_Lib Manual”), the list of addresses present in this menu will indicate the external Modbus TCP/IP Clients allowed to access the CPU Modbus TCP/IP server. To add a new address, enter the new one in the first free position of the list. To delete an address, simply enter the number 0 (zero) in the location to be removed.

B-5-2 Modbus TC/IP Priority Addresses Table Menu

The rules to insert a desired value is the same just described above for the “Secure address table”. The addresses specified in the “Priority connection table” are managed in a very particular dedicated way because the Modbus TCP/IP server agent can sustain up to 10 TCP client simultaneous connections at the same time. So, when a new connection request is made, and all 10 available connections are already used, the system will close one of the active connections to satisfy the new request. Addresses not belonging to the “Priority connection table” will be closed as first, followed by those which have been inactive longest.

B-6 Local Analogue I/O Setup Menu

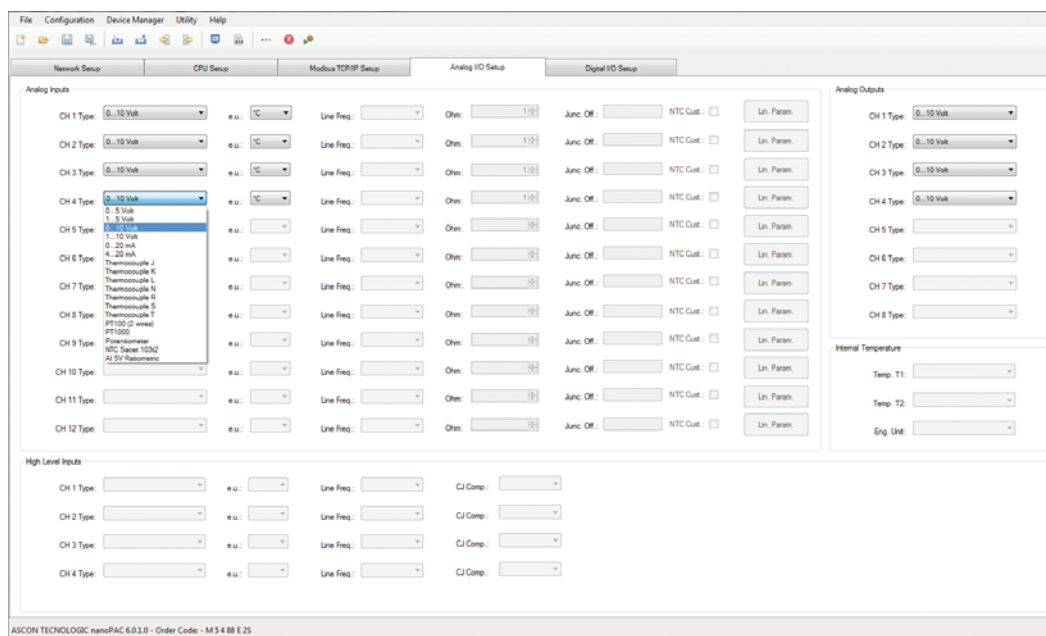

B-6-1 Setting the AI Channels

Note: The corresponding configuration choices for all the 4 analogue input channels is as described in the following table.

Analogue Input Type and Range	
Type	Range
0... 5 Volt	0.0... 5.5 V
1... 5 Volt	0.6... 5.4 V
0... 10 Volt	0.0... 11.0 V
0... 20 mA	0.0... 22.0 mA
4... 20 mA	2.4... 21.6 mA
Thermocouple J	-245.25... +1235.5°C
Thermocouple K	-249.3... +1411.3°C
Thermocouple L	-220.0... +620.00°C
Thermocouple N	-32.5... +1332.5°C
Thermocouple R	-40.0... +1640.0°C
Thermocouple S	-44.0... +1804.0°C
Thermocouple T	-215.0... +415.0°C
PT100 (2 wires)	-232.3... +882.7°C
PT1000	-232.3... +882.7°C
Potentiometer	0... 1000000 Ω
NTC SEMITEC 103AT-2	-56.5... +141.5°C
Ratiometric 5 V	0.0... 5.5 V

B-6-2 Analogue Output Ch1 - Ch2 or Ch3 - Ch4 Menu

Analogue Output Types
0... 5 Volt
1... 5 Volt
0... 10 Volt
2... 10 Volt
0... 20 mA
4... 20 mA

B-7 Local Digital I/O Setup Menu

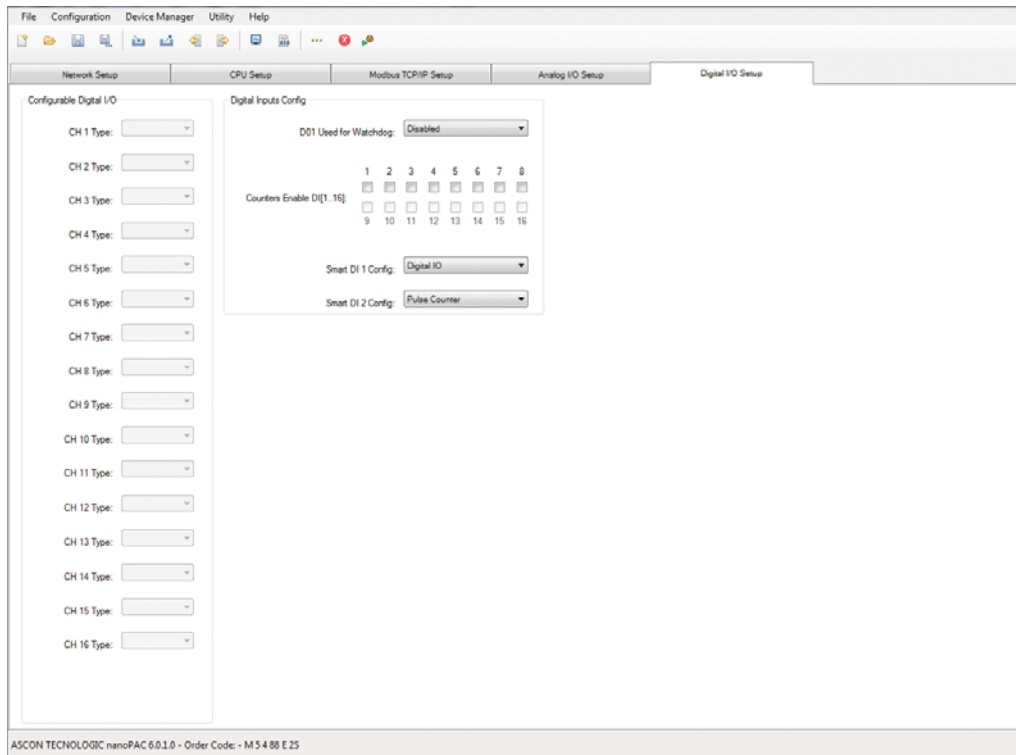

Note: The channels enabled in the “Configurable Digital I/O” part are automatically configured by the Wizard accordingly to the number of I/Os selected during the project creation. Note that the 16 digital I/O can freely be set only when the “16 Configurable Digital Channels + 2 Pulse Count” selection has been made.

B-7-1 Configuring the Digital I/Os type

I/O Channel	Digital Input/Output Types	
	Default value	Selectable values
Ch1 (D01)	Input	Input/Output
...
Ch16 (D16)	Input	Input/Output

Note: The Channels can freely be set only when the “16 Configurable Digital Channels + 2 Pulse Count” selection has been made.

B-7-2 Digital Input/Output Config

I/O channel	Default value	Selectable values
D01 Used for Watchdog (note)	Disabled	Disabled/Enabled
Counters Enable DI[01... 16]	No (no checkmark)	Yes (checkmark)
Smart DI1 Config	Digital I/O	Digital I/O or Pulse Counter
Smart DI2 Config	Digital I/O	Digital I/O/ Pulse Counter

Note: The channel used by the nP04 for the Watchdog is Channel D16 and must be set as “**Output**”.

Appendix C

Reference documents

- [1] “Infoteam OpenPCS programming system – user manual”
- [2] “IEC 61131-3: Programming Industrial Automation Systems” – Karl-Heinz John, Michael Tiegelkamp - Springer
- [3] “Ascon Tecnologica Firmware Function Block Library”
- [4] “IEC 61131-3 Function Block Library”.
- [5] “Estensioni per gestire porte di comunicazione dell’ambiente OpenPCS” V1.0 – Maurizio Grassi
- [6] “Modbus Messaging on TCP/IP implementation guide”
- <http://www.Modbus-IDA.org>
- [7] “MODBUS over Serial Line Specification & Implementation guide”
- <http://www.Modbus-IDA.org>
- [8] “MODBUS APPLICATION PROTOCOL SPECIFICATION”
- <http://www.Modbus-IDA.org>
- [9] “nP4 Installation manual” (code: J30 - 658 - 1AnP4 E).
- [10] “nP4 User manual” (code: J30 - 478 - 1AnP4 E).
- [11] “**sigma**line I/O modules Installation Manuals”.
- [12] “**sigma**line I/O modules User Manuals”.

